

# ALPHA2 / ALPHA3 / ALPHA SOLAR

**Circulator pumps**

50/60 Hz



be  
think  
innovate

**GRUNDFOS** 

<b>1. General description</b>	<b>4</b>
Type key .....	4
Model type .....	4
Performance range .....	5
<b>2. Applications</b>	<b>6</b>
ALPHA2/3, the best choice for heating systems .....	7
ALPHA2/3 features .....	9
<b>3. Operating conditions</b>	<b>10</b>
Pumped liquids .....	10
Technical data .....	10
<b>4. Construction</b>	<b>11</b>
Sectional drawing .....	11
Material specification .....	11
Motor and control box .....	11
Unique air vent system .....	12
<b>5. Installation and startup</b>	<b>13</b>
Installation .....	13
Startup .....	13
Setting the pump .....	13
<b>6. Guide to performance curves</b>	<b>15</b>
Curve conditions .....	16
<b>7. Performance curves and technical data</b>	<b>17</b>
ALPHA2/3 15-40 .....	17
ALPHA2/3 15-50 .....	18
ALPHA2/3 15-60 .....	19
ALPHA2/3 15-80 .....	20
ALPHA2/3 25-40 (N) .....	21
ALPHA2/3 25-40 A .....	22
ALPHA2/3 25-50 (N) .....	23
ALPHA2/3 25-60 (N) .....	24
ALPHA2/3 25-60 A .....	25
ALPHA2/3 25-80 (N) .....	26
ALPHA2/3 32-40 (N) .....	27
ALPHA2/3 32-50 (N) .....	28
ALPHA2/3 32-60 (N) .....	29
ALPHA2/3 32-80 (N) .....	30
<b>8. Accessories</b>	<b>31</b>
Unions and valve kits .....	31
Insulating kits .....	31
ALPHA plugs .....	32
ALPHA Reader .....	32
<b>9. Product numbers</b>	<b>33</b>
ALPHA2 for the D-A-CH market* (Germany, Austria and Switzerland) .....	33
ALPHA3 for the D-A-CH market* (Germany, Austria and Switzerland) .....	35
ALPHA2 for the international market .....	36
ALPHA3 for the international market .....	38
ALPHA2 for the UK market .....	39
ALPHA3 for the UK market .....	39
ALPHA2 for the Russian market .....	40
ALPHA3 for the Russian market .....	40
<b>10. ALPHA SOLAR</b>	<b>41</b>
Product description .....	41
Features .....	41
Benefits .....	41
Technical data .....	41
Replacement table .....	41

Operating mode .....	42
Alarm status .....	42
Control box connections .....	42
Power supply connection .....	43
Control signal connection .....	43
Digital signal converter .....	43
ALPHA SOLAR for the international market .....	46
<b>11. Grundfos Product Center</b> .....	<b>47</b>

## 1. General description



TM06 4400 2315

Grundfos ALPHA2/ALPHA3, referred to as ALPHA2/3 in the following, is a complete range of circulator pumps with the following features:

- AUTO<sub>ADAPT</sub> function which is suitable for most installations.
- Integrated differential-pressure control enabling adjustment of pump performance to the actual system requirements.
- Automatic night setback, selectable.
- Manual summer mode.
- Dry-running protection.
- ALPHA Reader compatible from ALPHA2 model E\* and ALPHA3 model A.
- High-torque start.
- Display showing the actual power consumption in watt or the actual flow rate in m<sup>3</sup>/h.
- Motor based on permanent-magnet rotor/compact-stator technology.

\* Model E only available in a limited number of countries

ALPHA2/3 is energy-optimised and complies with the ErP Directive, Commission Regulation (EC) No 641/2009, which has been effective as from 1 January 2013.

The installation of an ALPHA2/3 pump will reduce the power consumption considerably, reduce noise from thermostatic radiator valves and similar fittings and improve the control of the system.

ALPHA2/3 offers a host of advantages:

<b>Energy savings</b>	Automatic control of the differential pressure.
<b>Flexibility</b>	Suitable for installation in existing systems.
<b>Night setback</b>	Automatic night setback, selectable.
<b>Manual summer mode</b>	Summer mode, selectable.
<b>Dry-running protection</b>	Protection of the pump against dry running during start and normal operation.
<b>Compatible with ALPHA Reader*</b>	Support for hydronic balancing of radiators and underfloor heating in heating systems.
<b>High-torque start</b>	Improved startup under harsh conditions.
<b>Comfort</b>	Low-noise operation.
<b>Safety</b>	Built-in electrical and thermal protection of the pump.
<b>User friendliness</b>	Simple setting and operation.
<b>Alarms</b>	Alarms indicated in the display.
<b>Warnings</b>	Warnings indicated in the display.

\* Depending on the model.

### Type key

Example	ALPHA2/3 25 - 40	180
Pump range		
Nominal diameter (DN) of inlet and outlet ports [mm] (15 = G 1*, 25 = G 1 1/2, 32 = G 2)		
Maximum head [dm]		
Cast-iron pump housing		
N: Stainless-steel pump housing		
A: Pump housing with air separator		
Port-to-port length [mm]		

\* Exception: UK version, size 15 = G 1 1/2.

### Model type

This data booklet covers all models. The model type is stated on the nameplate. See fig. 1.



TM06 1716 2515

Fig. 1 Model type on the nameplate

The table below shows the ALPHA2/3 models with built-in functions and features.

Functions/features	ALPHA2 model B	ALPHA2 model C	ALPHA2 model D	ALPHA2 model E*	ALPHA3 model A
	Starts from	PC 12xx**	PC 14xx**	PC 15xx**	PC 17xx**
		PC 15xx**			PC 15xx**
AUTO <sub>ADAPT</sub>	•	•	•	•	•
Proportional pressure	•	•	•	•	•
Constant pressure	•	•	•	•	•
Constant curve	•	•	•	•	•
Automatic night setback	•	•	•	•	•
Manual summer mode		•	•	•	•
Dry-running protection			•	•	•
ALPHA Reader				•	•
High-torque start			•	•	•
ALPHA2/3XX-40	•	•	•	•	•
ALPHA2/3XX-50 *	•	•	•	•	•
ALPHA2/3XX-60	•	•	•	•	•
ALPHA2/3XX-80		•	•	•	•

\* Model E only available in a limited number of countries.

\*\* Production code (Year-Week)

### Performance range

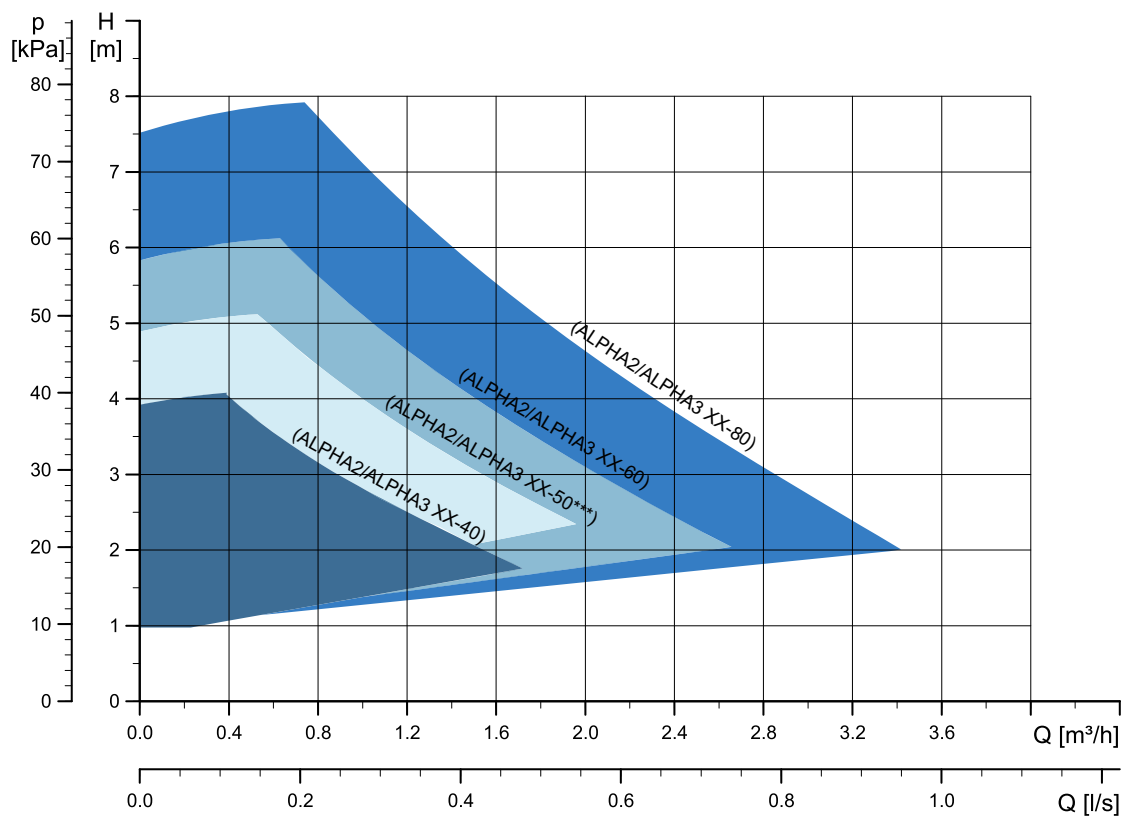

Fig. 2 Performance range, ALPHA2/3

\*\*\* Not available in all countries.

TM06 9198 1817

## 2. Applications

ALPHA2/3 is designed for circulating liquids in heating systems. You can also use pumps with stainless-steel pump housing in domestic hot-water systems.

ALPHA2/3 is suitable for the following systems:

- Systems with constant or variable flows where it is desirable to optimise the pump duty point.
- Systems with variable flow-pipe temperature.
- Systems where night setback is desired.

You can select the appropriate pump type for a heating system according to the following guidelines:

Range	Radiator system ( $\Delta t$ 20 °C)	Underfloor heating ( $\Delta t$ 5 °C)	Pump type
[m <sup>2</sup> ]	[m <sup>3</sup> /h]	[m <sup>3</sup> /h]	ALPHA2/3
80-120	0.4	1.5	XX-40
120-160	0.5	2.0	XX-50*
160-200	0.6	2.5	XX-60
200-300	0.8	3.5	XX-80

\* Not available in all countries.

**Note:** The data are approximate values. Grundfos cannot be held responsible for wrong sizing of pumps in heating systems.

ALPHA2/3 is especially suitable for the following:

- Installation in existing systems where the differential pressure of the pump is too high during periods of reduced flow demand.
- Installation in new systems for fully automatic adjustment of the performance to flow demands without the use of bypass valves or similar expensive components.

### Examples of systems

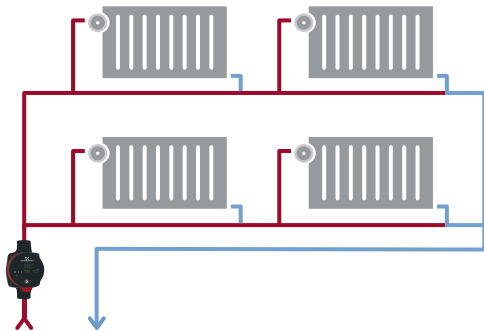

Fig. 3 One-pipe heating system

TM06 8563 1417

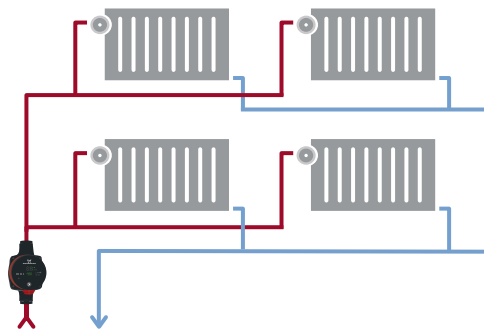

Fig. 4 Two-pipe heating system

TM06 8561 1417

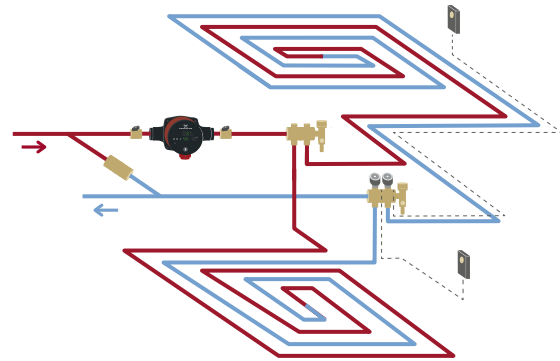

Fig. 5 Underfloor heating system

TM06 8560 1417

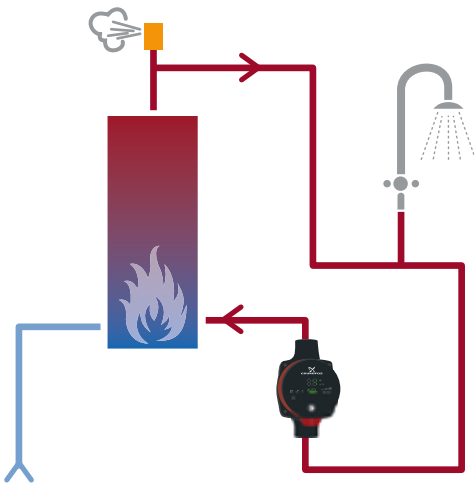

Fig. 6 Domestic hot-water recirculation system

TM06 8562 1417

## ALPHA2/3, the best choice for heating systems

The heating required in a building varies greatly during the day due to changing outdoor temperatures, solar radiation and heat emanating from people, electric appliances etc.

Add to this that the need for heating may vary from one section of the building to another and that the thermostatic valves of some radiators may have been turned down by the users.

These circumstances will cause an uncontrolled pump to produce a too high differential pressure when the heat demand is low.

Possible consequences:

- too high energy consumption
- irregular control of the system
- noise in thermostatic radiator valves and similar fittings.

ALPHA2/3 automatically controls the differential pressure by adjusting the pump performance to the actual heat demand, without the use of external components.

The pump has the following control modes:

- AUTO<sub>ADAPT</sub> control
- proportional-pressure control
- constant-pressure control
- constant-curve control.

## AUTO<sub>ADAPT</sub>

The integrated AUTO<sub>ADAPT</sub> function is especially developed for the following:

- underfloor heating systems
- two-pipe heating systems.

The AUTO<sub>ADAPT</sub> function (factory setting) automatically adjusts the pump performance to the actual heat demand, i.e. the size of the system and the changing heat demand. The performance is adjusted gradually over time. You cannot expect an optimum pump setting from day one.

If the power supply fails or is disconnected, the pump stores the AUTO<sub>ADAPT</sub> setting in an internal memory and will resume the automatic adjustment when the power supply has been restored.

## Operation

The AUTO<sub>ADAPT</sub> function enables ALPHA2/3 to control the pump performance automatically:

- adjustment of the pump performance to the heat demand in the system
- adjustment of the pump performance to the variations in load over 24 hours.

In AUTO<sub>ADAPT</sub> mode, the pump is set to proportional-pressure control.

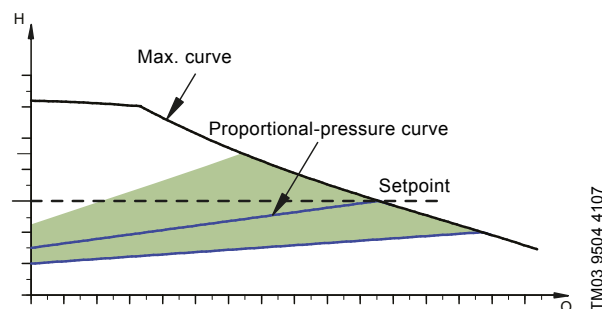

Fig. 7 AUTO<sub>ADAPT</sub> performance range

The AUTO<sub>ADAPT</sub> function differs from other control functions as it moves the control curve within a performance range. The marked area indicates the limits for the movement of the proportional-pressure curve. See fig. 7.

In a system with an uncontrolled pump, a pressure rise will often cause flow-generated noise in the thermostatic radiator valves. This noise will be reduced considerably with ALPHA2/3.

## Proportional-pressure control

Proportional-pressure control adjusts the pump performance to the actual heat demand in the system, but the pump performance follows the selected performance curve, PP1, PP2 or PP3. See fig. 8 where PP2 has been selected. See [Change of performance](#) on page 14 for further information.

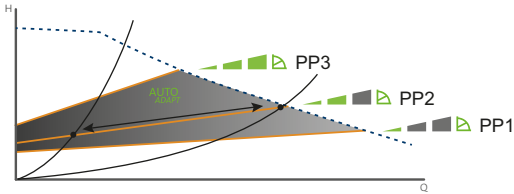

Fig. 8 Three proportional-pressure curves/settings

TM05 3064 0912

## Constant-pressure control

Constant-pressure control adjusts the pump performance to the actual heat demand in the system, but the pump performance follows the selected performance curve, CP1, CP2 or CP3. See fig. 9 where CP1 has been selected. See [Change of performance](#) on page 14 for further information.

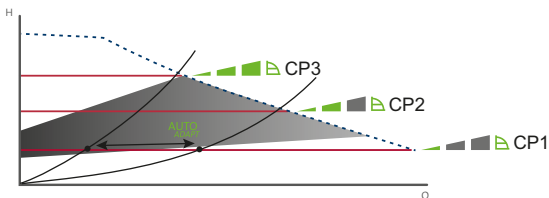

Fig. 9 Three constant-pressure curves/settings

TM05 3066 0912

The selection of the right constant-pressure setting depends on the characteristics of the heating system in question and the actual heat demand.

## Constant-curve control

At constant-curve/constant-speed operation, the pump runs at a constant speed, independent of the actual flow demand in the system. The pump performance follows the selected performance curve, I, II or III. See fig. 10 where II has been selected. See [Change of performance](#) on page 14 for further information.

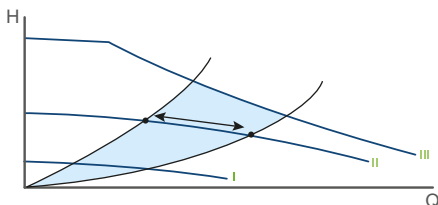

Fig. 10 Three constant-curve/constant-speed settings

TM06 8822 1217

The selection of the right constant-curve/constant-speed setting depends on the characteristics of the heating system in question and the number of taps likely to be opened at the same time.

## Advantages of ALPHA pump control

In ALPHA2/3, control is effected by adapting the differential pressure to the flow (proportional-pressure and constant-pressure control).

Contrary to an uncontrolled pump, the proportional-pressure-controlled ALPHA2/3 reduces the differential pressure as a result of falling heat demand.

If the heat demand falls, for instance due to solar radiation, the thermostatic radiator valves will close, and, for the uncontrolled pump, the flow resistance of the system will rise, for instance from  $A_1$  to  $A_2$ . See fig. 11.

In a heating system with an uncontrolled pump, this situation will cause a pressure rise in the system by  $\Delta H_1$ .

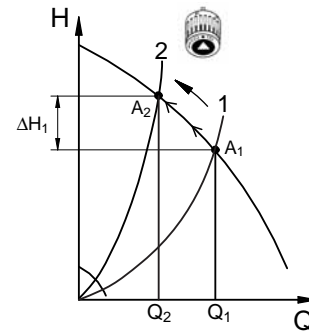

Fig. 11 Uncontrolled pump

TM01 9119 5002

In a system with an ALPHA2/3 pump set to proportional-pressure control, the differential pressure will be reduced by  $\Delta H_2$  and result in reduced energy consumption. See fig. 12.

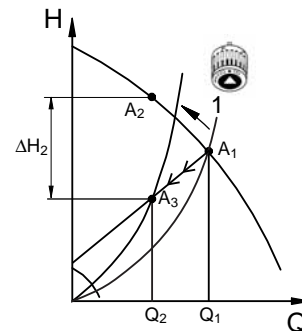

Fig. 12 Pump in proportional-pressure control mode

TM01 9120 5002

## Overview of control mode

Application	Control mode
Floor heating	Constant pressure
Two pipe system	AUTO <sub>ADAPT</sub> or proportional pressure
Ventilation	Speed 1, 2 or 3
Boiler-shunt	Speed 1, 2 or 3
One pipe system	Speed 1, 2 or 3 or constant pressure
Domestic hot water	Speed 1, 2 or 3



## ALPHA2/3 features

### Automatic night setback

You enable the automatic night setback with the  button on the control box.

Factory setting: Disabled.

**Note:** If you have set the pump to speed I, II or III, you cannot enable automatic night setback.

Once you have enabled automatic night setback, the pump automatically changes between normal duty and night setback. The changeover depends on the flow-pipe temperature measured by the integrated temperature sensor.

#### Function

If automatic night setback is to be used in the system, you must install the pump in the flow pipe.

Changeover between normal duty and night setback depends on the flow-pipe temperature.

The pump automatically changes over to night setback when a flow-pipe temperature drop of more than 10 to 15 °C within approx. two hours is registered. The temperature drop must be at least 0.1 °C/min.

Changeover to normal duty takes place without a time lag when the flow-pipe temperature has increased by approx. 10 °C.

### Manual summer mode

You can select the manual summer mode as from ALPHA2 model C and ALPHA3 model A.

You enable the manual summer mode with the  button on the front of the control box.

#### Function

In the manual summer mode, the pump is automatically started at low speed to avoid blocking the rotor as well as sticky valves and non-return valves. The display is turned off.

If any alarms occur during the manual summer mode, no alarms will be shown. When you deactivate the manual summer mode again, only the actual alarms will be displayed.

You deactivate the manual summer mode by pressing any of the buttons, and then the pump returns to the previous mode and setting.

If you have enabled the automatic night setback mode before setting the manual summer mode, the pump will return to automatic night setback mode after the manual summer mode.

### Dry-running protection

**Dry-running protection is active as from ALPHA2 model D and ALPHA3 model A**

The new active dry-run feature protects the reliable wet-runner design of the ALPHA2/3 pumps.

Dry-running protection protects the pump against dry running during start and normal operation. The user will be informed via an error code in the display.

## ALPHA Reader

### ALPHA Reader is an accessory

It is only suitable for ALPHA2 model E\* and ALPHA3 model A.

This feature is used for hydronic balancing radiators and underfloor heating in heating systems in a fast and safe way for the benefit of the installer as well as the end-user.

ALPHA Reader provides read-out of internal data from the pump. See fig. 13. The data will be transmitted to the handheld device, e.g. smartphone or tablet. In order to perform a balancing of the system, you must download the *Grundfos GO balance* app, which is available in Apple App Store and Google Play.

ALPHA Reader is only necessary during hydraulic balancing and can be removed afterwards. See also [Accessories](#) on page 32.



Fig. 13 ALPHA3 and an ALPHA Reader

\* Only available in a limited number of countries

### High-torque start

**High-torque start is active as from ALPHA2 model D and ALPHA3 model A**

In case of a blocked rotor, the pump will start vibrating automatically with a frequency of around 3 Hz during startup. Any dirt deposits that might prevent the impeller from rotating will be broken up swiftly, and the pump will resume normal operation.

TM06 5810 0216

## 3. Operating conditions

### Pumped liquids

The pump is suitable for the following liquids:

- clean, thin, non-aggressive and non-explosive liquids, not containing solid particles or fibres
- cooling liquids, not containing mineral oil
- softened water.

The kinematic viscosity of water is  $\nu = 1 \text{ mm}^2/\text{s}$  (1 cSt) at 20 °C. If you use the pump for a liquid with a higher viscosity, the hydraulic performance of the pump will be reduced.

**Example:** 50 % glycol at 20 °C means a viscosity of approx. 10 mm<sup>2</sup>/s (10 cSt) and a reduction of pump performance by approx. 15 %.

Do not use additives that in any way can or will disturb the functionality of the pump.

When selecting a pump, take the viscosity of the pumped liquid into consideration.

### Technical data

#### Liquid temperature

ALPHA2/3 pumps: 2-110 °C.

In domestic hot-water systems, we recommend that you keep the liquid temperature between 50 and 65 °C to eliminate the risk of lime precipitation.

#### System pressure

PN 10: Maximum 1.0 MPa (10 bar).

#### Inlet pressure

To avoid cavitation noise and damage to the pump bearings, the following minimum pressures are required at the inlet port.

Liquid temperature	75 °C	90 °C	110 °C
	0.5 m head	2.8 m head	10.8 m head
Inlet pressure	0.005 MPa	0.028 MPa	0.108 MPa
	0.05 bar	0.28 bar	1.08 bar

### Electrical data

Supply voltage	1 x 230 V ± 10 %, 50/60 Hz, PE.
Motor protection	The pump requires no external motor protection.
Enclosure class	IPX4D.
Insulation class	F.
Relative air humidity	Maximum 95 %.
Ambient temperature	0-40 °C.
Temperature class	TF110 to CEN 335-2-51.
EMC (electromagnetic compatibility)	EMC Directive (2014/30/EU) Standards used: EN 55014-1:2006/A1:2009/A2:2011 EN 55014-2:2015 EN61000-3-2:2014 EN61000-3-3:2013
Sound pressure level	≤ 43 dB(A).

## 4. Construction

ALPHA2/3 is designed for long and trouble-free operation as a canned-rotor type, i.e. pump and motor form an integral unit without shaft seal, with only one gasket for sealing. The bearings are lubricated by the pumped liquid. These constructions ensure maintenance-free operation.

The pump is characterised by the following:

- Permanent-magnet rotor/compact-stator motor which contributes to high efficiency and high starting torque.
- Ceramic shaft and radial bearings which contribute to long life.
- Carbon thrust bearing which contributes to long life.
- Stainless-steel rotor can, bearing plate and rotor cladding which contribute to corrosion-free long life.
- Composite impeller which contributes to corrosion-free long life.
- Cast-iron or stainless-steel pump housing which contributes to flexibility.
- Automatic air venting which contributes to easy commissioning.
- Compact design featuring pump head with integrated control box and control panel which fits into most common installations.

### Sectional drawing

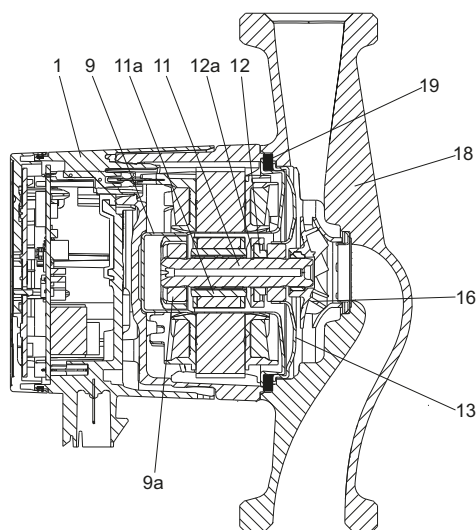

Fig. 14 Position numbers

TM05 2518 0112

### Material specification

Pos.	Description	Material	EN/DIN	AISI/ASTM
1	Controller complete	Composite, PC		
9	Rotor can	Stainless steel	1.4401	316
9a	Radial bearing	Ceramics		
11	Shaft	Ceramics		
11a	Rotor cladding	Stainless steel	1.4401	316
12	Thrust bearing	Carbon		
12a	Thrust bearing retainer	EPDM rubber		
13	Bearing plate	Stainless steel	1.4301	304
16	Impeller	Composite, PES		
18	Pump housing	Cast iron	EN-GJL-150	A48-150B
		Stainless steel	1.4308	351 CF8
19	Gasket	EPDM rubber		

### Motor and control box

The motor is a 4-pole synchronous permanent-magnet motor.

The pump controller is incorporated in the control box, which is fitted to the stator housing and connected to the stator via a terminal plug.

The control box has an integrated control panel with three push-buttons (1, 2 and 3) and a 2-digit 7-segment display. See fig. 15.

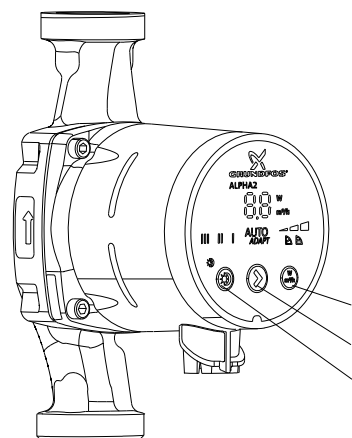

TM05 2519 0112

Fig. 15 Position of push-buttons

Pos.	Description
1	Push-button for selection of pump setting.
2	Push-button for enabling or disabling of automatic night setback or manual summer mode. You have to activate both settings manually.
3	Push-button for selection of parameter to be shown in the display, i.e. actual power consumption in watt or actual flowrate in m <sup>3</sup> /h.

The display is on when you have switched on the power supply. The display shows the actual pump power consumption in watt (integer) or the actual flowrate in m<sup>3</sup>/h, in steps of 0.1 m<sup>3</sup>/h, during operation.

Faults preventing the pump from operating properly are indicated by fault codes in the display, for example in the case of a blocked rotor.

The following faults can be indicated in the display:

- E1: blocked rotor
- E2: insufficient supply voltage
- E3: electrical fault
- E4: dry-run.

Figures 16 and 17 show the possible control box positions in heating systems as well as in air-conditioning and cold-water systems.

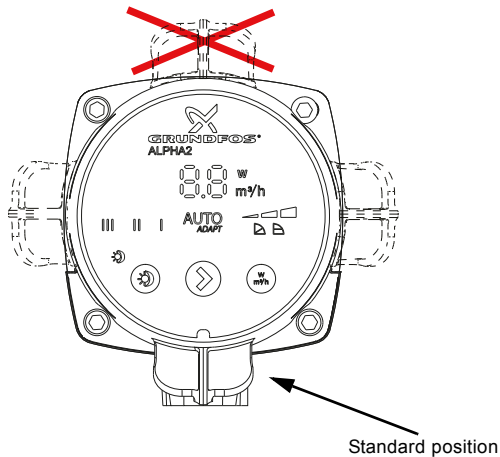

TM05 2520 0112

Fig. 16 Possible control box positions, heating systems

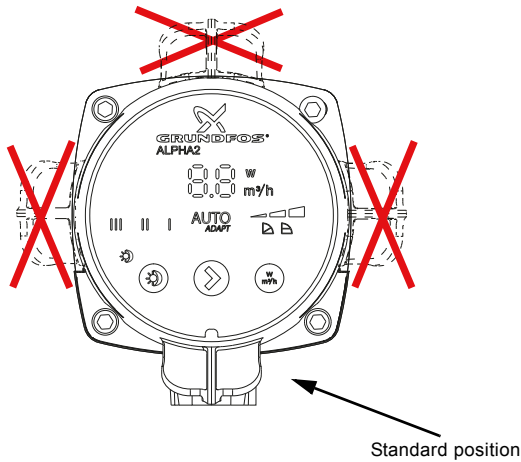

TM05 2700 0112

Fig. 17 Possible control box position, air-conditioning and cold-water systems

The plug incorporates cable relief and a locking function for securing the connection of the supply cable.



TM06 5823 0116

Fig. 18 1) ALPHA plug with cable gland (standard)  
2) ALPHA plug angled 90 ° left, with cable gland  
3) ALPHA plug angled 90 ° left, with fixed cable.

## Unique air vent system

The pump housing with air separator is installed in systems where the liquid contains so much air that a circulator pump without air separator cannot start or keep up a continuous circulation. The pump housing is available only for upward water flows.

The air-containing liquid is guided from the inlet port to the nozzle of the air-separating chamber and caused to circulate considerably in the relatively large chamber, thus creating a relatively lower pressure at the back (top) of the chamber. This lower pressure combined with the reduced velocity of the liquid in the air-separating chamber will cause a separation of air from the liquid. Due to its lower density, the air will escape through an automatic air vent fitted to the air-separating chamber.

The pump housing has an Rp 3/8 tapping for fitting of an air vent. The air vent is not supplied with the pump.

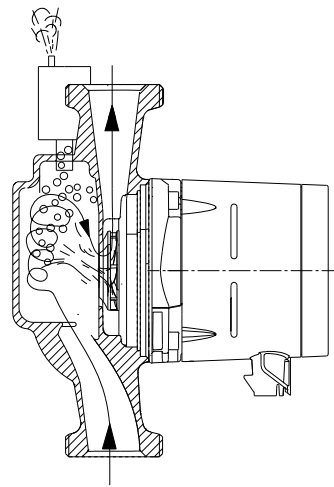

TM05 2521 0112

Fig. 19 Pump housing with air-separating chamber

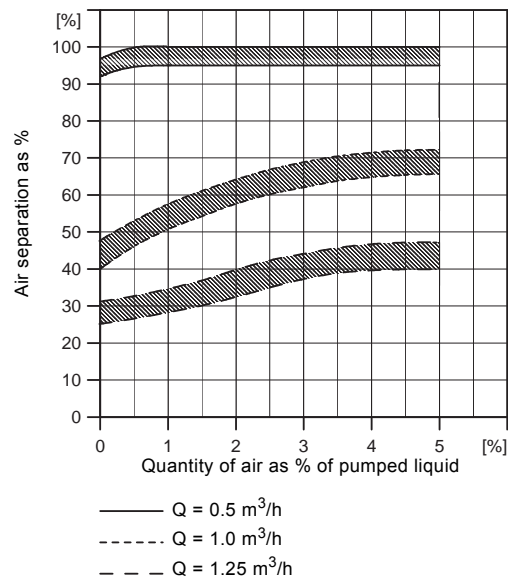

TM00 9101 1097

Fig. 20 Air separation

## 5. Installation and startup

### Installation

In most cases, the installation of ALPHA2/3 is reduced to the mechanical installation and connection to the power supply.

Always install the pump with horizontal motor shaft.

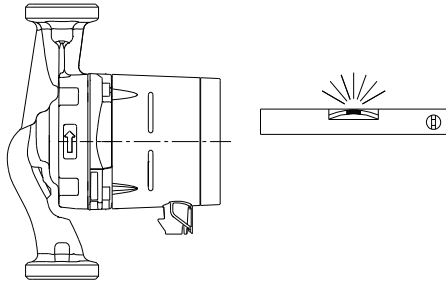

Fig. 21 Horizontal motor shaft

TM05 2522 0112

### Startup

Do not start the pump until the system has been filled with liquid. Make sure that the required minimum inlet pressure is available at the pump inlet.

When using the pump for the first time, the system must be vented at the highest point.

The pump is self-venting through the system.

To avoid condensation in the control box and stator, the liquid temperature must always be higher than the ambient temperature. See table below.

Ambient temperature [°C]	Liquid temperature	
	Min. [°C]	Max. [°C]
0	2	110
10	10	110
20	20	110
30	30	110
35	35	90
40	40	70

The ALPHA2/3 pump can, however, run at ambient temperatures higher than the liquid temperature if the plug connection in the pump head is pointing downwards. See figures 16 and 17.

### Setting the pump

With the push-button on the control box, you can set the electronically controlled pump to the following:

- AUTO<sub>ADAPT</sub>
- three proportional-pressure curves (PP1, PP2, PP3)
- three constant-pressure curves (CP1, CP2, CP3)
- three constant curves/constant speeds (I, II, III).

### Factory setting

The push-buttons on the pump control box have been factory-set as shown in the table below.

These settings are suitable for a large majority of all single- and two-family houses.

Pump type	Setting	Automatic night setback	Manual summer mode
ALPHA2/3 XX-40			
ALPHA2/3 XX-50*			
ALPHA2/3 XX-60	AUTO <sub>ADAPT</sub>	Disabled	Disabled
ALPHA2/3 XX-80			

\* Not available in all countries.

## Change of performance

You can change the pump performance (flow rate and head) by pressing the control box push-button as indicated in fig. 22 and the table below.

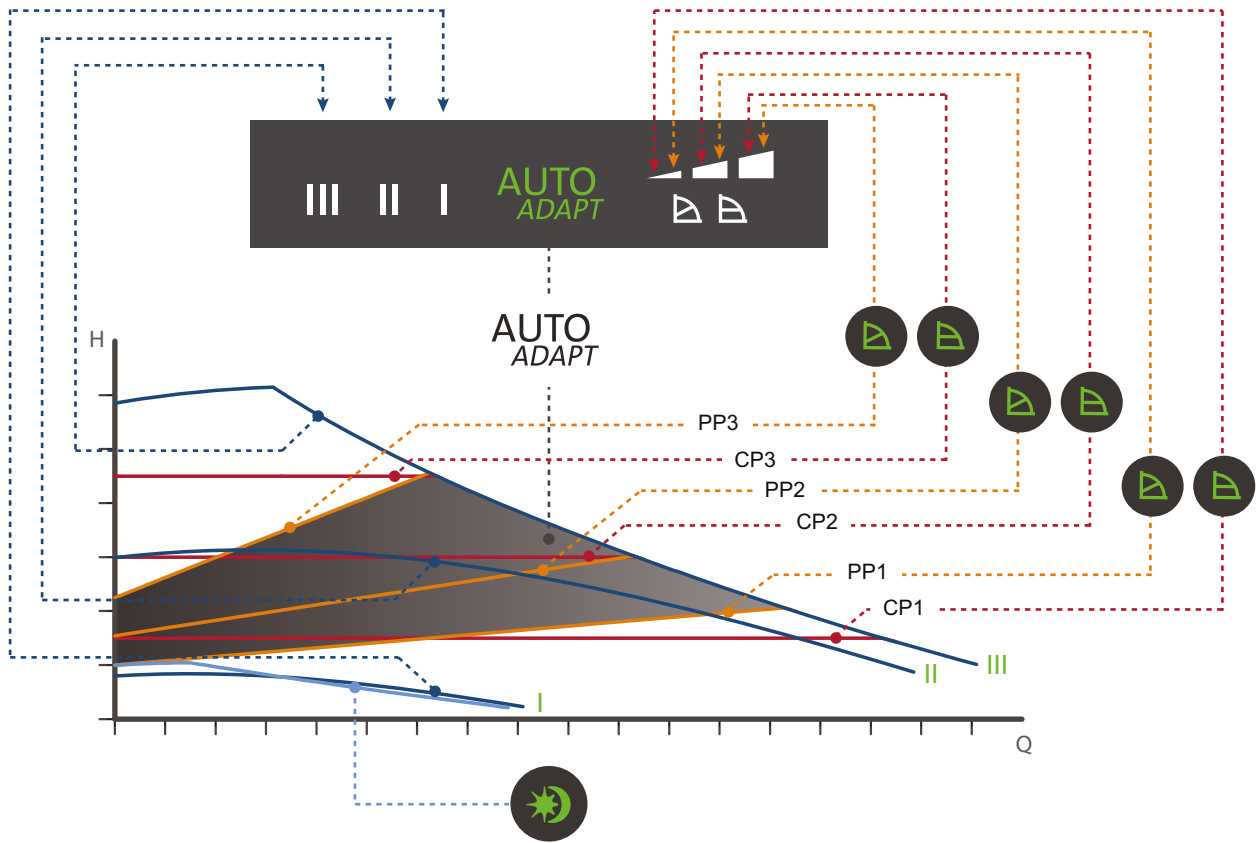

TM05 2771 0412

Fig. 22 Pump setting in relation to pump performance

Setting	Pump curve	Function
AUTO <sub>ADAPT</sub> factory setting	Highest to lowest proportional-pressure curve	The AUTO <sub>ADAPT</sub> function enables the pump to control the pump performance automatically within a defined performance range. See fig. 22. <ul style="list-style-type: none"> <li>• Adjustment of the pump performance to the size of the system.</li> <li>• Adjustment of the pump performance to the variations in load over time.</li> </ul> In AUTO <sub>ADAPT</sub> , the pump is set to proportional-pressure control.
PP1	Lowest proportional-pressure curve	The duty point of the pump will move up or down on the lowest proportional-pressure curve, depending on the heat demand in the system. See fig. 22. The head (pressure) is reduced at falling heat demand and increased at rising heat demand.
PP2	Intermediate proportional-pressure curve	The duty point of the pump will move up or down on the intermediate proportional-pressure curve, depending on the heat demand in the system. See fig. 22. The head (pressure) is reduced at falling heat demand and increased at rising heat demand.
PP3	Highest proportional-pressure curve	The duty point of the pump will move up or down on the highest proportional-pressure curve, depending on the heat demand in the system. See fig. 22. The head (pressure) is reduced at falling heat demand and increased at rising heat demand.
CP1	Lowest constant-pressure curve	The duty point of the pump will move out or in on the lowest constant-pressure curve, depending on the heat demand in the system. See fig. 22. The head (pressure) is kept constant, irrespective of the heat demand.
CP2	Intermediate constant-pressure curve	The duty point of the pump will move out or in on the intermediate constant-pressure curve, depending on the heat demand in the system. See fig. 22. The head (pressure) is kept constant, irrespective of the heat demand.
CP3	Highest constant-pressure curve	The duty point of the pump will move out or in on the highest constant-pressure curve, depending on the heat demand in the system. See fig. 22. The head (pressure) is kept constant, irrespective of the heat demand.
III	Speed III	The pump runs on a constant curve which means that it runs at a constant speed. In speed III, the pump is set to run on the maximum curve under all operating conditions. See fig. 22. You can obtain quick venting of the pump by setting the pump to speed III for a short period.
II	Speed II	The pump runs on a constant curve which means that it runs at a constant speed. In speed II, the pump is set to run on the intermediate curve under all operating conditions. See fig. 22.
I	Speed I	The pump runs on a constant curve which means that it runs at a constant speed. In speed I, the pump is set to run on the minimum curve under all operating conditions. See fig. 22.
	Automatic night setback and manual summer mode	The pump changes to the curve for automatic night setback, i.e. absolute minimum performance and power consumption, provided that certain conditions are met. In manual summer mode, the pump is automatically started frequently at low speed to avoid a blocking rotor. The display is turned off. See <a href="#">ALPHA2/3 features</a> on page 9.

## 6. Guide to performance curves

Each pump setting has its own performance curve (Q/H curve). However, AUTO<sub>ADAPT</sub> covers a performance range. A power curve, P1, belongs to each Q/H curve. The power curve shows the pump power consumption in watt at a given Q/H curve.

The P1 value corresponds to the value that you can read from the pump display. See fig. 23.

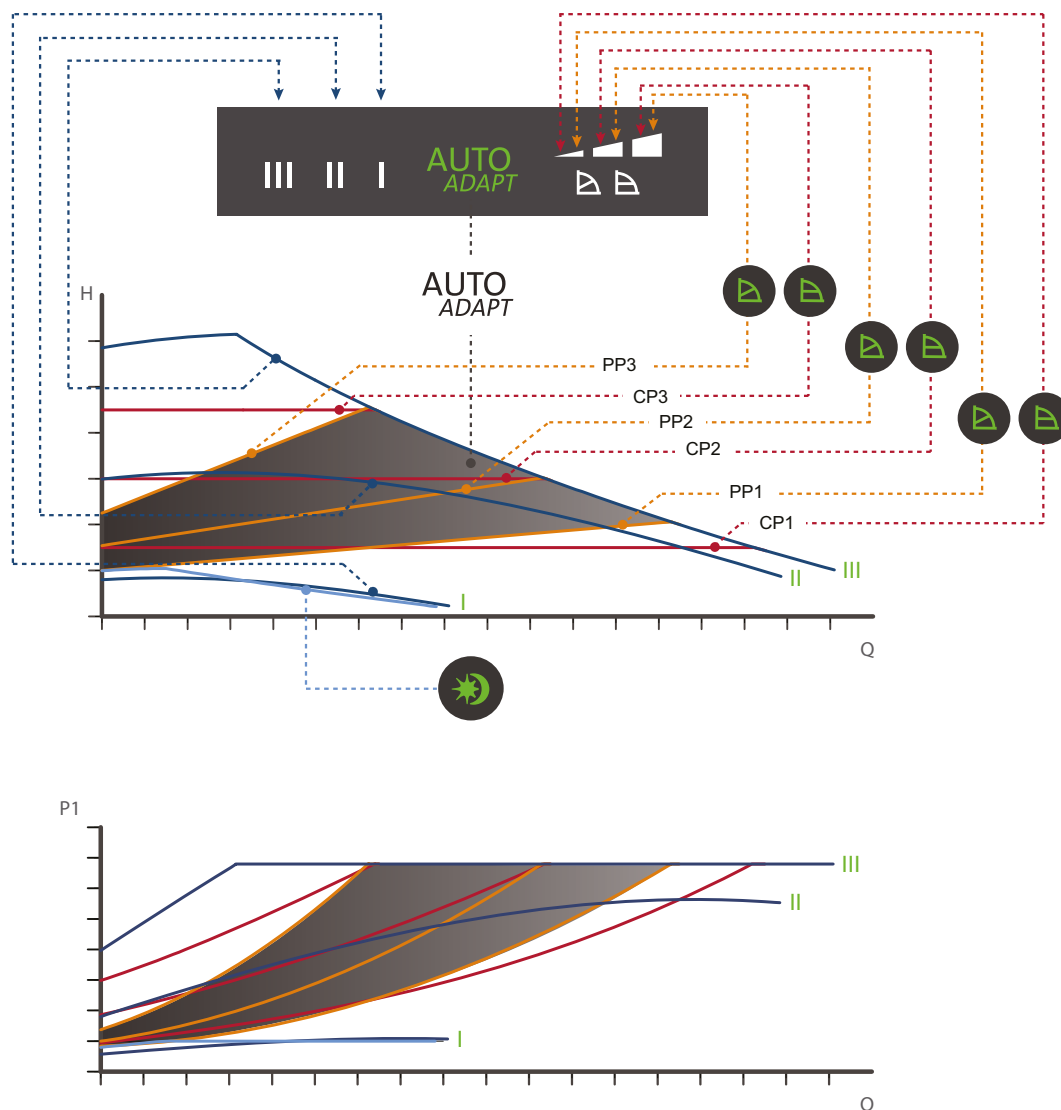



Fig. 23 Performance curves in relation to pump setting

Setting	Pump curve
AUTO <sub>ADAPT</sub> (factory setting)	Setpoint within the marked area
PP1	Lowest proportional-pressure curve
PP2	Intermediate proportional-pressure curve
PP3	Highest proportional-pressure curve
CP1	Lowest constant-pressure curve
CP2	Intermediate constant-pressure curve
CP3	Highest constant-pressure curve
III	Constant curve/constant speed III
II	Constant curve/constant speed II
I	Constant curve/constant speed I
	Curve for automatic night setback/manual summer mode

TM05 2578 0312

## Curve conditions

The guidelines below apply to the performance curves on pages 17 to 29:

- Test liquid: airless water.
- The curves apply to a density of  $\rho = 983.2 \text{ kg/m}^3$  and a liquid temperature of  $60 \text{ }^\circ\text{C}$ .
- All curves show average values and must not be used as guarantee curves. If a specific minimum performance is required, make individual measurements.
- The curves for speeds I, II and III are marked.
- The curves apply to a kinematic viscosity of  $\nu = 0.474 \text{ mm}^2/\text{s}$  (0.474 cSt).
- The conversion between head  $H$  [m] and pressure  $p$  [kPa] has been made for water with a density of  $\rho = 1000 \text{ kg/m}^3$ . For liquids with other densities, for example hot water, the outlet pressure is proportional to the density.
- Curves obtained according to EN 16297.

## Symbols used on the following pages

For ALPHA2/3 pumps, the energy efficiency index (EEI) is down to  $\text{EEI} \leq 0.15$  and categorised as best in class.

ALPHA2/3 with  $\text{AUTO}_{ADAPT}$  function is the preferred choice for domestic installations and a true efficiency frontrunner.

The EEI is an indicator of the efficiency of the circulator and is the relation between the weighted average electrical input power of the ALPHA2/3 (considering standardized load profile) and the average input power of a standard circulator having the same hydraulic output power.

The ALPHA2/3 EEI is far below the ErP 2015 requirements and even exceeds the best in class benchmark level. See fig. 24.

The benchmark for the most efficient circulators is  $\text{EEI} \leq 0.20$

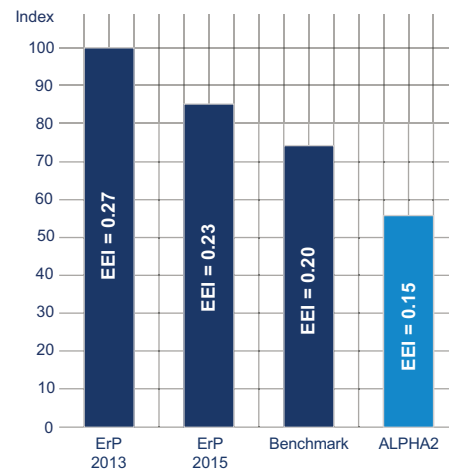

Fig. 24 EEI limits and the current positioning of the ALPHA2/3

With an energy efficiency index (EEI) well below the ErP benchmark level, you can achieve energy savings of up to 85 % compared to a typical circulator and thus a remarkably fast return on investment. This means, of course, that ALPHA2/3 more than meets the standards of the ErP legislation.

For more information about the new energy directive, please visit:



energy.grundfos.com

TM05 4002 1517

TM05 2683 0412



## 7. Performance curves and technical data

### ALPHA2/3 15-40

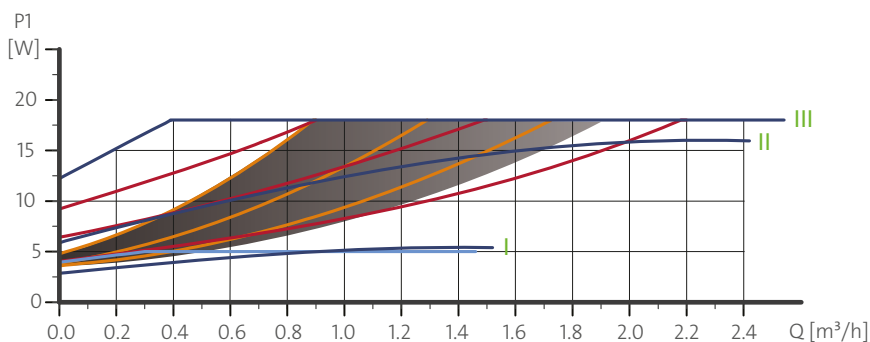
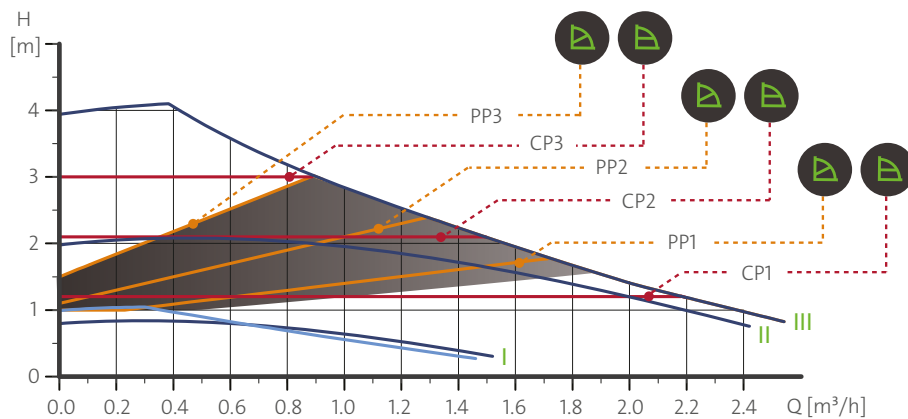

TM05 1672.4.111 - TM06 3966 1315

Speed	P1 [W]	I <sub>1</sub> [A]
<b>AUTO<sub>ADAPT</sub></b>	4-18	0.04 - 0.18
<b>Min.</b>	3	0.04
<b>Max.</b>	18	0.18

Connections: See [Unions and valve kits](#), page 31.

System pressure: Maximum 1.0 MPa (10 bar).

Liquid temperature: 2-110 °C (TF 110).

Specific EEI: ≤ 0.15.

The pump incorporates overload protection.

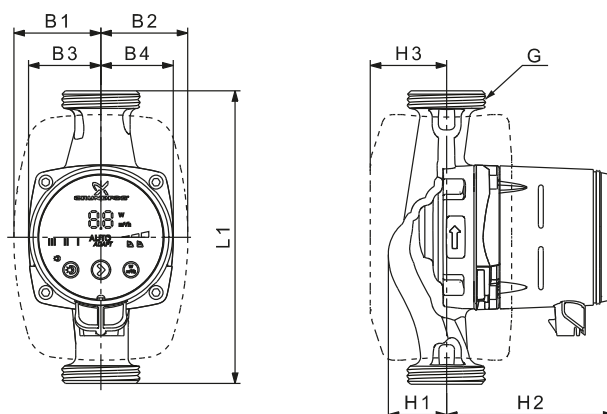

TM05 2364 5011

Pump type	Dimensions [mm]									Weights [kg]		Ship. vol. [m³]
	L1	B1	B2	B3	B4	H1	H2	H3	G	Net	Gross	
ALPHA2/3 15-40	130	54	54	44.5	44.5	35.8	103.5	47	G 1	1.7	1.9	0.00364

See product numbers and QR codes in section [Product numbers](#) on page 33.

# ALPHA2/3 15-50

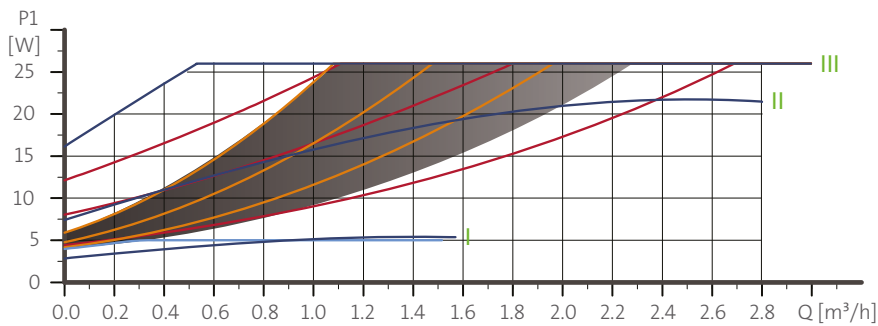
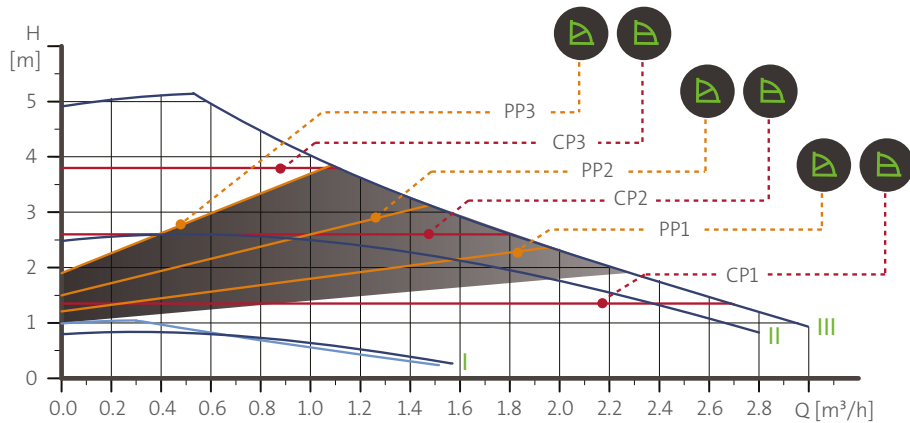

Speed	P1 [W]	I <sub>l</sub> [A]
<b>AUTO<sub>ADAPT</sub></b>	4-26	0.04 - 0.24
<b>Min.</b>	3	0.04
<b>Max.</b>	26	0.24

Connections: See [Unions and valve kits](#), page 31.  
 System pressure: Maximum 1.0 MPa (10 bar).  
 Liquid temperature: 2-110 °C (TF 110).  
 Specific EEI: ≤ 0.16.

The pump incorporates overload protection.

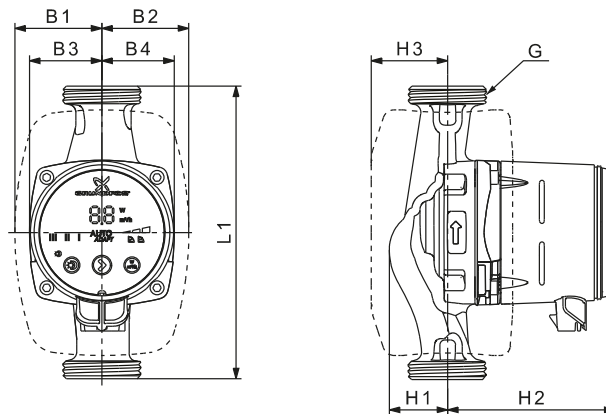

Pump type	Dimensions [mm]									Weights [kg]		Ship. vol. [m³]
	L1	B1	B2	B3	B4	H1	H2	H3	G	Net	Gross	
ALPHA2/3 15-50	130	54	54	44.5	44.5	35.8	103.5	47	G 1*	1.7	1.9	0.00364

See product numbers and QR codes in section [Product numbers](#) on page 33.

TM05 1673 4111

TM05 2364 5011

# ALPHA2/3 15-60

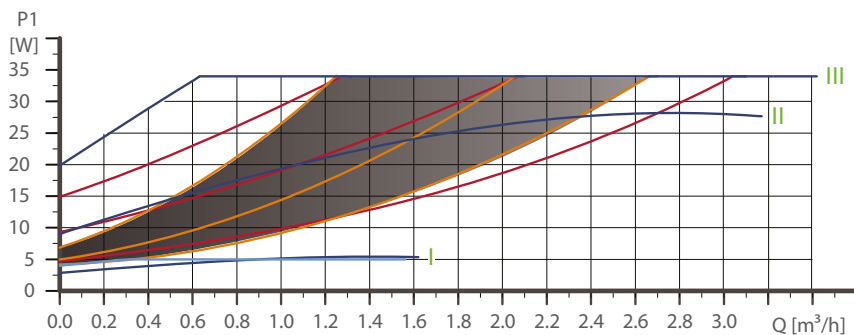
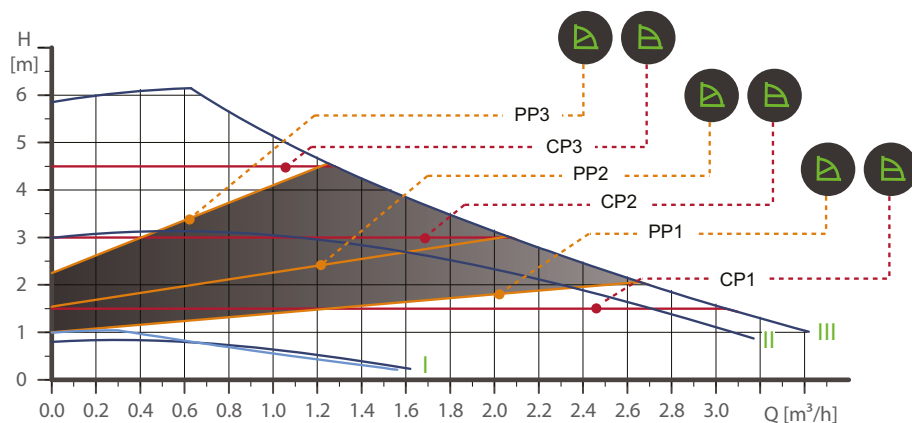

TM05 1674 4111 - TM06 3966 1315

Speed	P1 [W]	I <sub>1</sub> [A]
<b>AUTO<sub>ADAPT</sub></b>	4-34	0.04 - 0.32
<b>Min.</b>	3	0.04
<b>Max.</b>	34	0.32

- Connections: See [Unions and valve kits](#), page 31.
- System pressure: Maximum 1.0 MPa (10 bar).
- Liquid temperature: 2-110 °C (TF 110).
- Specific EEI: ≤ 0.17.

The pump incorporates overload protection.

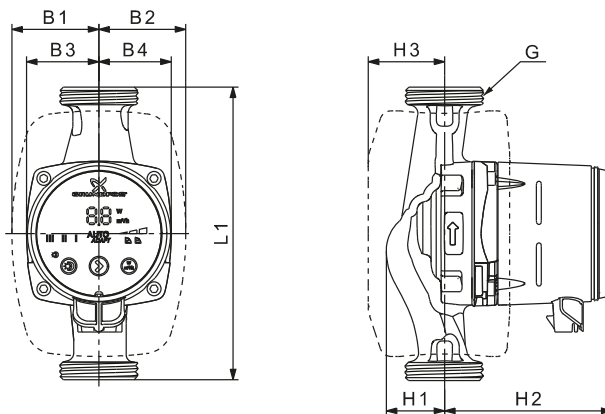

TM05 2364 5011

Pump type	Dimensions [mm]								Weights [kg]		Ship. vol. [m³]	
	L1	B1	B2	B3	B4	H1	H2	H3	G	Net		Gross
ALPHA2/3 15-60	130	54	54	44.5	44.5	35.8	103.5	47	G 1*	1.7	1.9	0.00364

\* UK version: ALPHA2/3 15-50/60 G 1 1/2.

See product numbers and QR codes in section [Product numbers](#) on page 33.

## ALPHA2/3 15-80

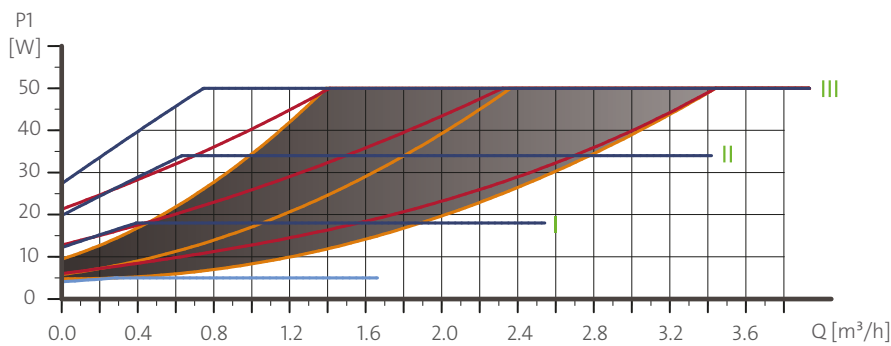
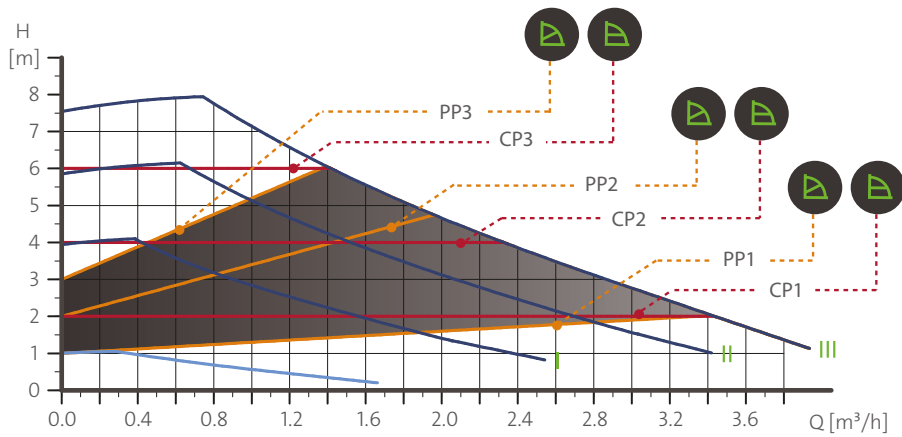

Speed	P1 [W]	I <sub>1</sub> [A]
AUTO <sub>ADAPT</sub>	4-50	0.04 - 0.44
Min.	3	0.04
Max.	50	0.44

The pump incorporates overload protection.

Connections: See [Unions and valve kits](#), page 31.  
 System pressure: Maximum 1.0 MPa (10 bar).  
 Liquid temperature: 2-110 °C (TF 110).  
 Specific EEI: ≤ 0.18.

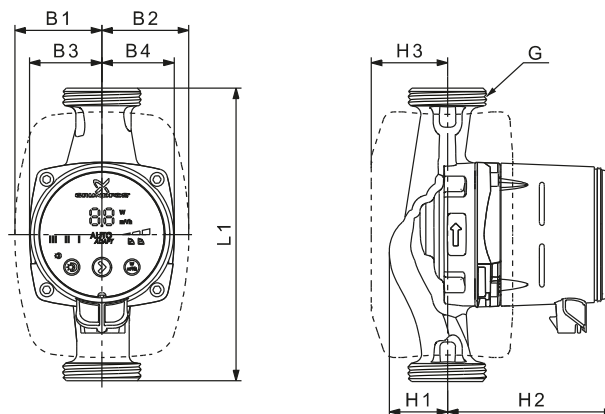

Pump type	Dimensions [mm]									Weights [kg]		Ship. vol. [m³]
	L1	B1	B2	B3	B4	H1	H2	H3	G	Net	Gross	
ALPHA2/3 15-80	130	54	54	44.5	44.5	35.8	103.5	47	G 1	1.7	1.9	0.00364

See product numbers and QR codes in section [Product numbers](#) on page 33.

TM06 1285 2114

TM05 2364 5011

## ALPHA2/3 25-40 (N)

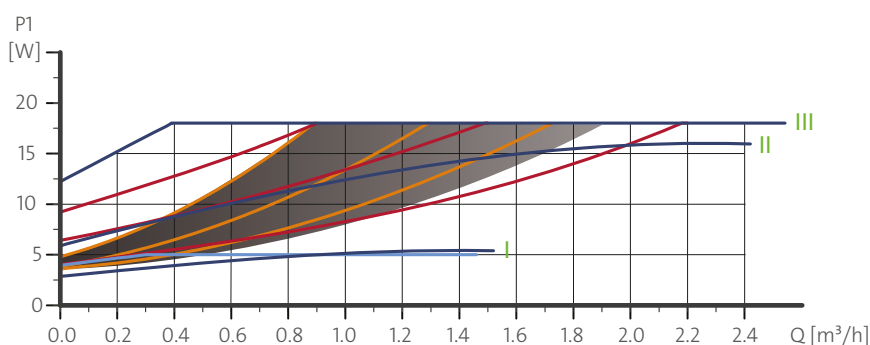
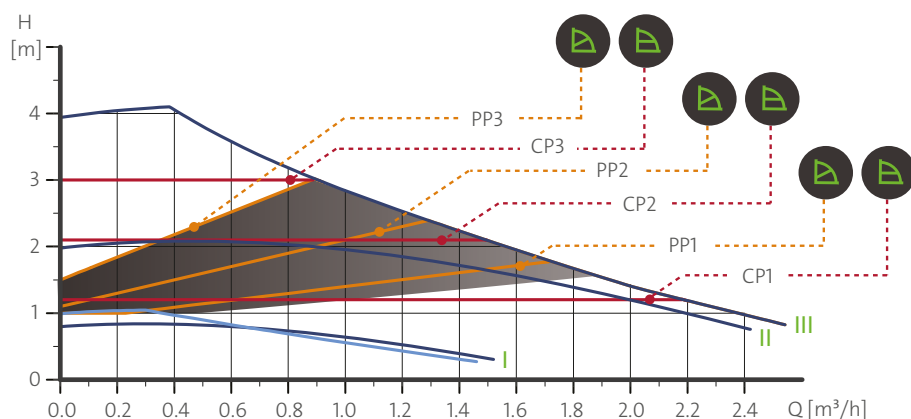

Speed	P1 [W]	I <sub>1</sub> [A]
AUTO <sub>ADAPT</sub>	4-18	0.04 - 0.18
Min.	3	0.04
Max.	18	0.18

The pump incorporates overload protection.

Connections: See [Unions and valve kits](#), page 31.

System pressure: Maximum 1.0 MPa (10 bar).

Liquid temperature: 2-110 °C (TF 110).

Also available with: Stainless-steel pump housing, type N.

Specific EEI: ≤ 0.15.

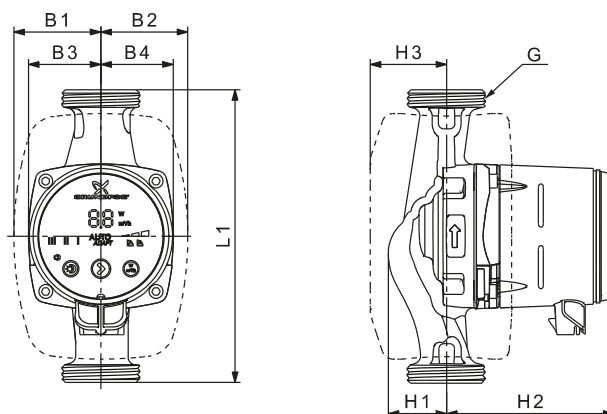

TM05 1672 4111 - TM06 3966 1315

TM05 2364 5011

Pump type	Dimensions [mm]								Weights [kg]		Ship. vol. [m <sup>3</sup> ]	
	L1	B1	B2	B3	B4	H1	H2	H3	G	Net		Gross
ALPHA2/3 25-40	130	54	54	44.5	44.5	35.9	103.5	47	G 1 1/2	1.9	2.0	0.00364
ALPHA2 25-40 N	130	54	54	44.5	44.5	36.8	103.5	47	G 1 1/2	2.0	2.1	0.00364
ALPHA2/3 25-40	180	54	54	44.5	44.5	35.9	103.5	47	G 1 1/2	2.0	2.1	0.00364
ALPHA2 25-40 N	180	54	54	44.5	44.5	36.9	103.5	47	G 1 1/2	2.1	2.3	0.00364

See product numbers and QR codes in section [Product numbers](#) on page 33.

# ALPHA2/3 25-40 A

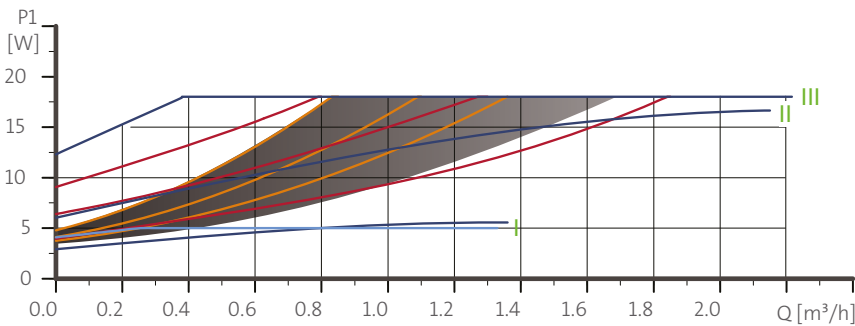
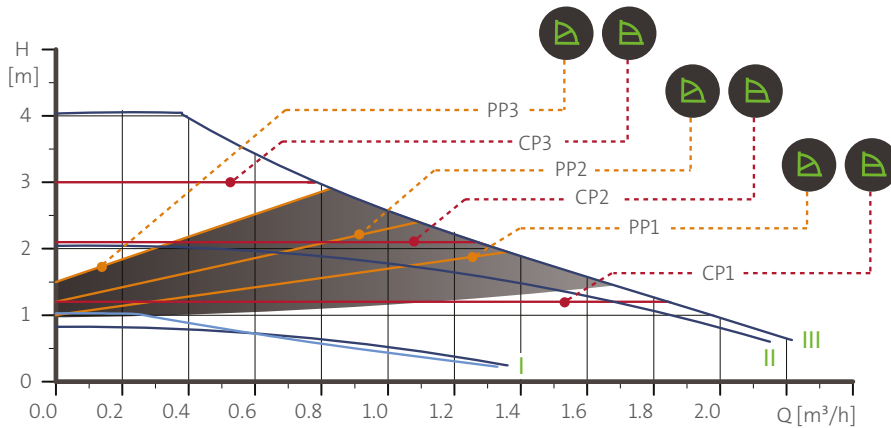

Speed	P1 [W]	I <sub>1</sub> [A]
<b>AUTO<sub>ADAPT</sub></b>	4-18	0.04 - 0.18
<b>Min.</b>	3	0.04
<b>Max.</b>	18	0.18

- Connections: See [Unions and valve kits](#), page 31.
- System pressure: Maximum 1.0 MPa (10 bar).
- Liquid temperature: 2-110 °C (TF 110).
- Specific EEI: ≤ 0.18.

The pump incorporates overload protection.

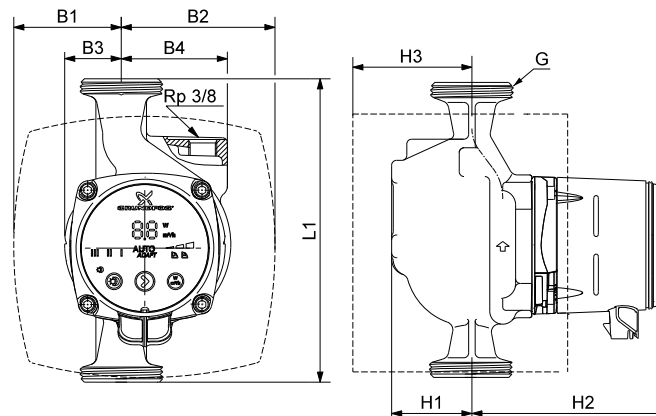

Pump type	Dimensions [mm]									Weights [kg]		Ship. vol. [m <sup>3</sup> ]
	L1	B1	B2	B3	B4	H1	H2	H3	G	Net	Gross	
ALPHA2/3 25-40 A	180	63.5	98	32	63	50	124	81	G 1 1/2	2.9	3.0	0.00420

See product numbers and QR codes in section [Product numbers](#) on page 33.

TM05 2016 4211

TM05 2574 0212

## ALPHA2/3 25-50 (N)

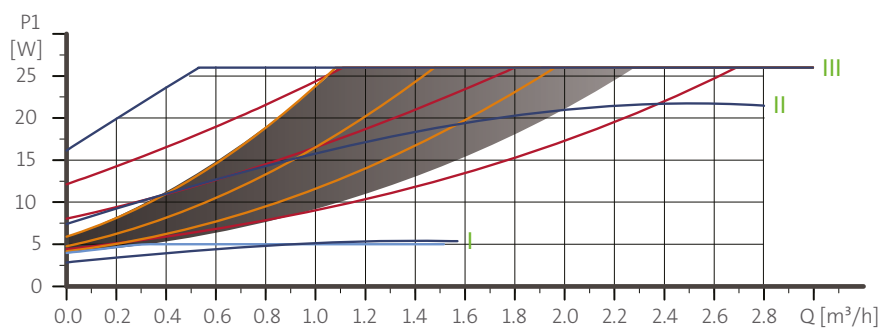
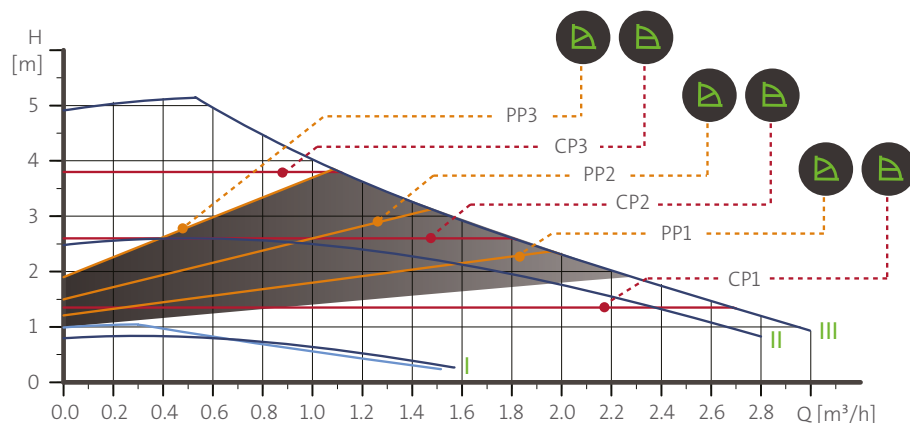

Speed	P1 [W]	I <sub>1</sub> [A]
AUTO <sub>ADAPT</sub>	4-26	0.04 - 0.24
Min.	3	0.04
Max.	26	0.24

The pump incorporates overload protection.

Connections: See [Unions and valve kits](#), page 31.

System pressure: Maximum 1.0 MPa (10 bar).

Liquid temperature: 2-110 °C (TF 110).

Also available with: Stainless-steel pump housing, type N.

Specific EEI: ≤ 0.16.

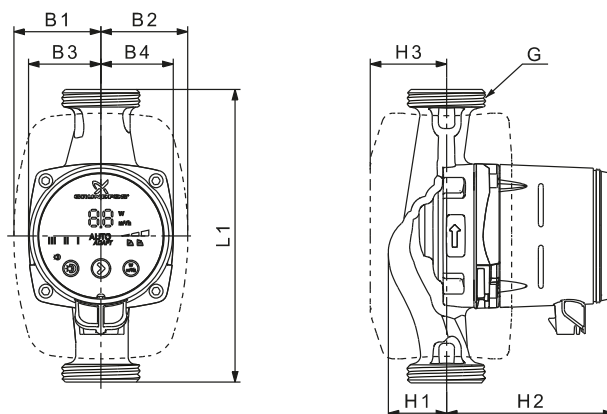

Pump type	Dimensions [mm]									Weights [kg]		Ship. vol. [m³]
	L1	B1	B2	B3	B4	H1	H2	H3	G	Net	Gross	
ALPHA2/3 25-50	130	54	54	44.5	44.5	35.8	103.5	52	G 1 1/2	1.9	2.0	0.00364
ALPHA2 25-50 N	130	54	54	44.5	44.5	36.8	103.5	52	G 1 1/2	2.0	2.1	0.00364
ALPHA2/3 25-50	180	54	54	44.5	44.5	35.9	103.5	52	G 1 1/2	2.0	2.1	0.00364
ALPHA2 25-50 N	180	54	65	44.5	44.5	36.9	103.5	52	G 1 1/2	2.1	2.3	0.00364

See product numbers and QR codes in section [Product numbers](#) on page 33.

TM05 1673 4111

TM05 2364 5011

## ALPHA2/3 25-60 (N)

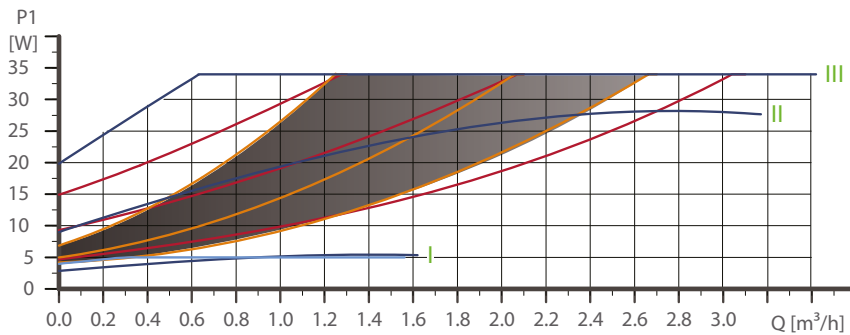
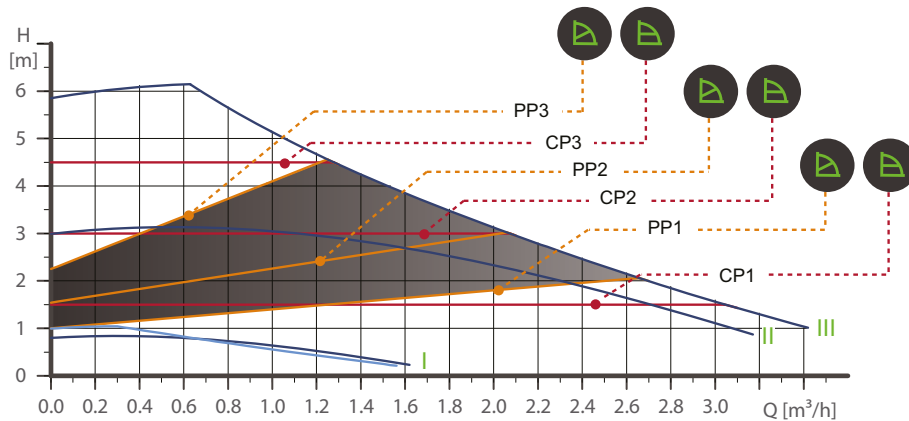

Speed	P1 [W]	I <sub>1</sub> [A]
AUTO <sub>ADAPT</sub>	4-34	0.04 - 0.32
Min.	3	0.04
Max.	34	0.32

The pump incorporates overload protection.

Connections: See [Unions and valve kits](#), page 31.

System pressure: Maximum 1.0 MPa (10 bar).

Liquid temperature: 2-110 °C (TF 110).

Also available with: Stainless-steel pump housing, type N.

Specific EEI: ≤ 0.17.

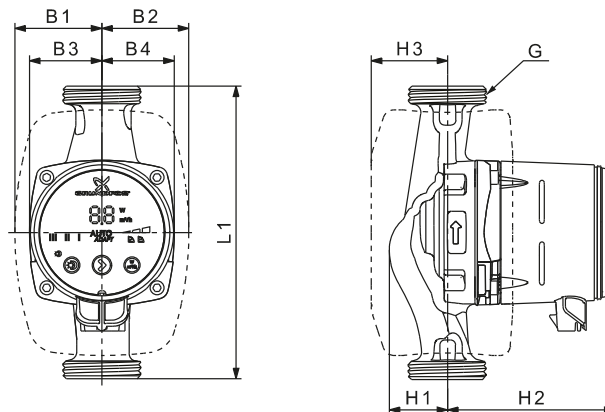

Pump type	Dimensions [mm]					Weights [kg]		Ship. vol. [m³]				
	L1	B1	B2	B3	B4	H1	H2		Net	Gross		
ALPHA2/3 25-60	130	54	54	44.5	44.5	35.8	103.5	47	G 1 1/2	1.9	2.0	0.00364
ALPHA2 25-60 N	130	54	54	44.5	44.5	36.8	103.5	47	G 1 1/2	2.0	2.1	0.00364
ALPHA2/3 25-60	180	54	54	44.5	44.5	35.9	103.5	47	G 1 1/2	2.0	2.1	0.00364
ALPHA2 25-60 N	180	54	54	44.5	44.5	36.9	103.5	47	G 1 1/2	2.1	2.3	0.00364

See product numbers and QR codes in section [Product numbers](#) on page 33.

TM05 1674 4111 - TM06 3966 1315

TM05 2364 5011



## ALPHA2/3 25-60 A

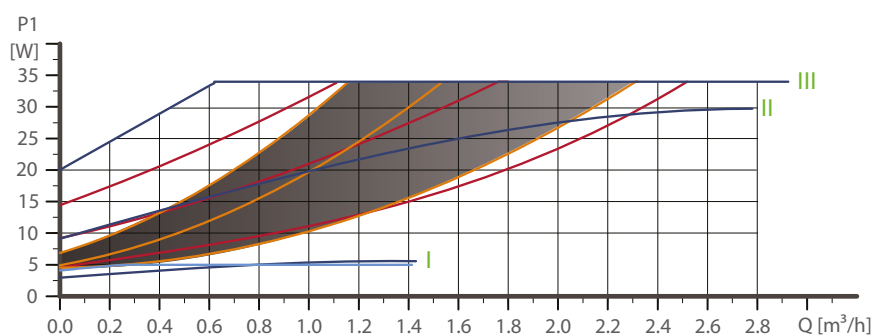
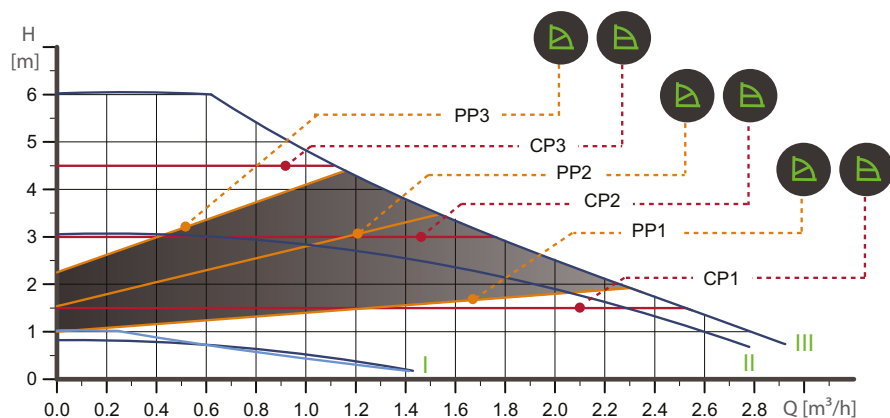

Speed	P1 [W]	I <sub>1</sub> [A]
AUTO <sub>ADAPT</sub>	4-34	0.04 - 0.32
Min.	3	0.04
Max.	34	0.32

Connections: See [Unions and valve kits](#), page 31.  
 System pressure: Maximum 1.0 MPa (10 bar).  
 Liquid temperature: 2-110 °C (TF 110).  
 Specific EEI: ≤ 0.20.

The pump incorporates overload protection.

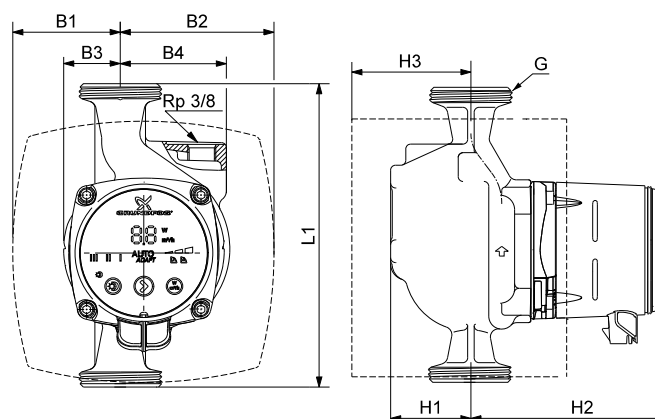

Pump type	Dimensions [mm]								Weights [kg]		Ship. vol. [m <sup>3</sup> ]	
	L1	B1	B2	B3	B4	H1	H2	H3	G	Net		Gross
ALPHA2/3 25-60 A	180	63.5	98	32	63	50	124	81	G 1 1/2	2.9	3.0	0.00420

See product numbers and QR codes in section [Product numbers](#) on page 33.

TM05 2017 4211

TM05 2574 0212

## ALPHA2/3 25-80 (N)

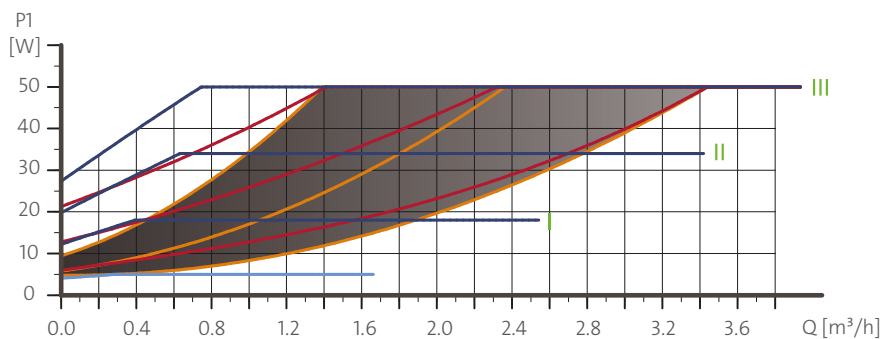
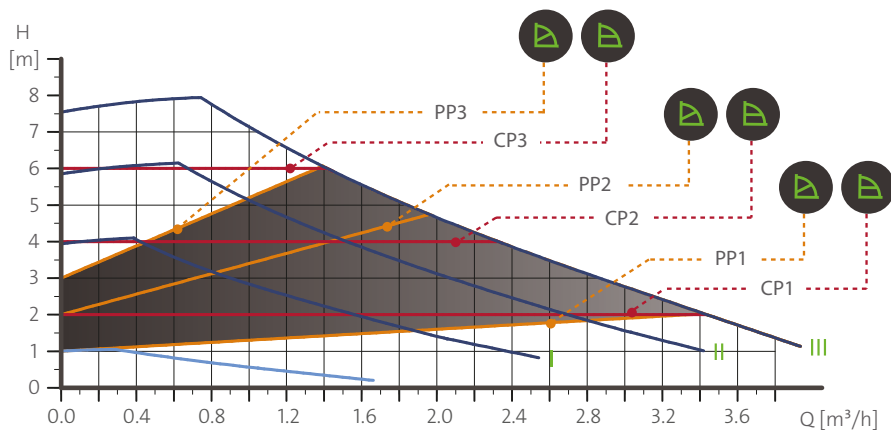

TM06 1285 2114

Speed	P1 [W]	I <sub>1</sub> [A]
<b>AUTO<sub>ADAPT</sub></b>	4-50	0.04 - 0.44
<b>Min.</b>	3	0.04
<b>Max.</b>	50	0.44

The pump incorporates overload protection.

Connections: See [Unions and valve kits](#), page 31.

System pressure: Maximum 1.0 MPa (10 bar).

Liquid temperature: 2-110 °C (TF 110).

Also available with: Stainless-steel pump housing, type N.

Specific EEI: ≤ 0.18.

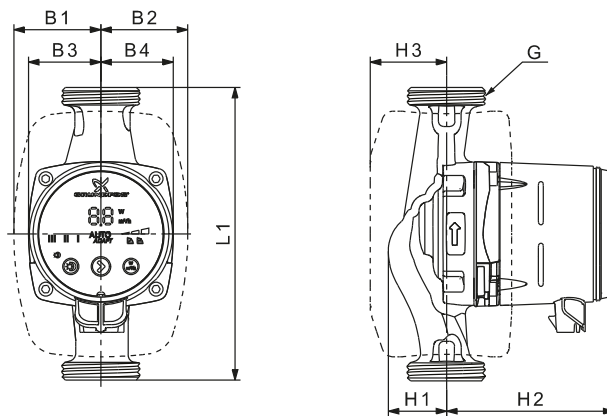

TM05 2364 5011

Pump type	Dimensions [mm]								Weights [kg]		Ship. vol. [m <sup>3</sup> ]	
	L1	B1	B2	B3	B4	H1	H2	H3	G	Net		Gross
ALPHA2/3 25-80	130	54	54	44.5	44.5	35.8	103.5	47	G 1 1/2	1.9	2.0	0.00364
ALPHA2 25-80 N	130	54	54	44.5	44.5	36.8	103.5	47	G 1 1/2	2.0	2.1	0.00364
ALPHA2/3 25-80	180	54	54	44.5	44.5	35.9	103.5	47	G 1 1/2	2.0	2.1	0.00364
ALPHA2 25-80 N	180	54	54	44.5	44.5	36.9	103.5	47	G 1 1/2	2.1	2.3	0.00364

See product numbers and QR codes in section [Product numbers](#) on page 33.

## ALPHA2/3 32-40 (N)

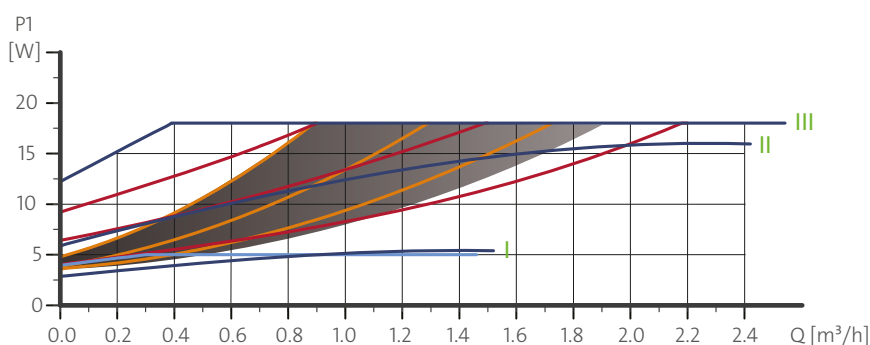
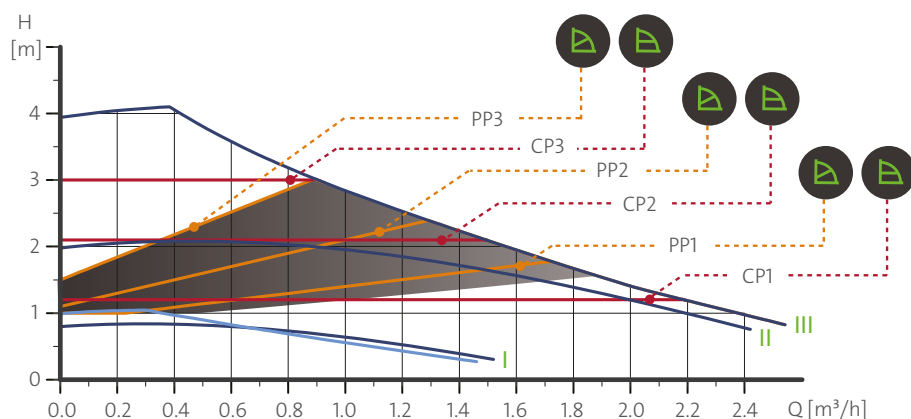

Speed	P1 [W]	I <sub>1</sub> [A]
AUTO <sub>ADAPT</sub>	4-18	0.04 - 0.18
Min.	3	0.04
Max.	18	0.18

The pump incorporates overload protection.

Connections: See [Unions and valve kits](#), page 31.

System pressure: Maximum 1.0 MPa (10 bar).

Liquid temperature: 2-110 °C (TF 110).

Also available with: Stainless-steel pump housing, type N.

Specific EEI: ≤ 0.15.

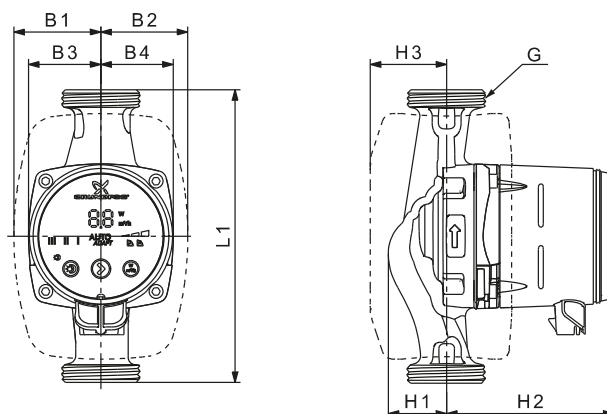

TM05 1672 4111 - TM06 3966 1315

TM05 2364 5011

Pump type	Dimensions [mm]									Weights [kg]		Ship. vol. [m <sup>3</sup> ]
	L1	B1	B2	B3	B4	H1	H2	H3	G	Net	Gross	
ALPHA2/3 32-40	180	54	54	44.5	44.5	35.9	103.5	47	G 2	2.1	2.3	0.00364
ALPHA2 32-40 N	180	54	54	44.5	44.5	36.9	103.5	47	G 2	2.3	2.4	0.00364

See product numbers and QR codes in section [Accessories](#) on page 33.

## ALPHA2/3 32-50 (N)

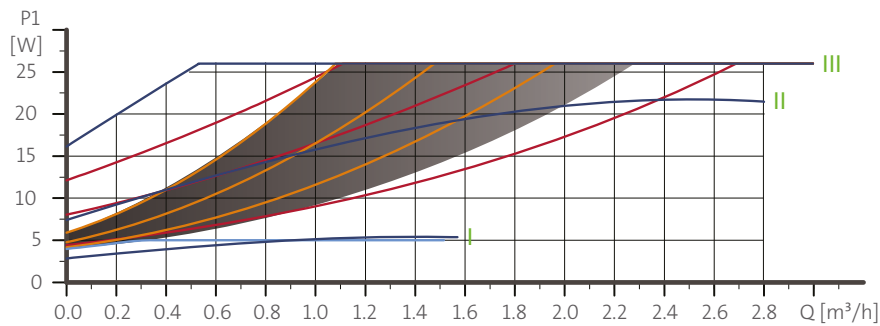
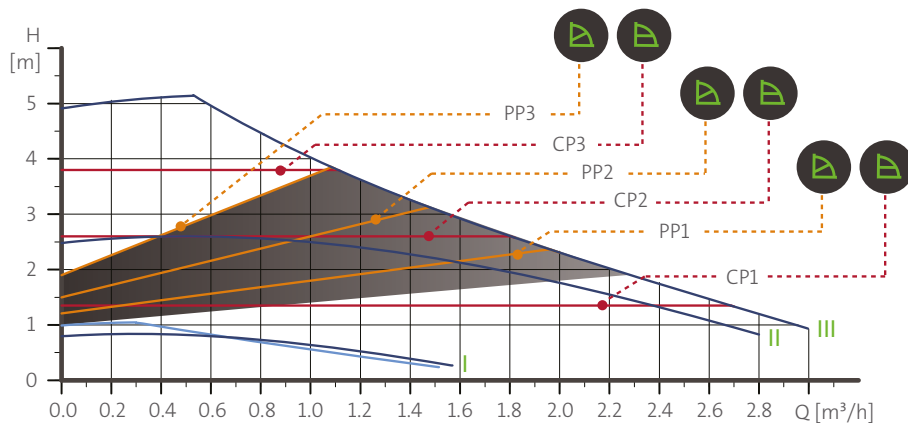

Speed	P1 [W]	I <sub>l</sub> [A]
<b>AUTO<sub>ADAPT</sub></b>	4-26	0.04 - 0.24
<b>Min.</b>	3	0.04
<b>Max.</b>	26	0.24

The pump incorporates overload protection.

Connections: See [Unions and valve kits](#), page 31.

System pressure: Maximum 1.0 MPa (10 bar).

Liquid temperature: 2-110 °C (TF 110).

Also available with: Stainless-steel pump housing, type N.

Specific EEI: ≤ 0.16.

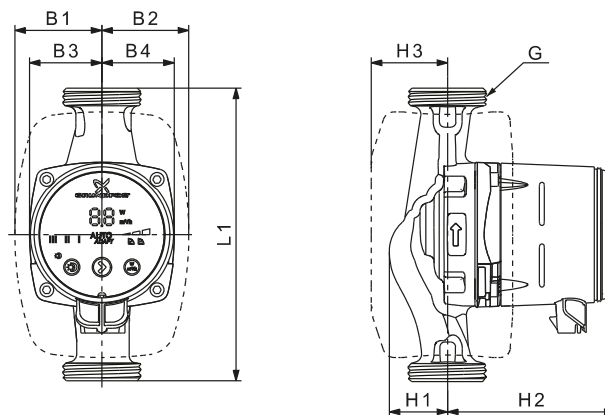

Pump type	Dimensions [mm]									Weights [kg]		Ship. vol. [m³]
	L1	B1	B2	B3	B4	H1	H2	H3	G	Net	Gross	
ALPHA2/3 32-50	180	54	54	44.5	44.5	35.9	103.5	47	G 2	2.1	2.3	0.00364
ALPHA2 32-50 N	180	54	54	44.5	44.5	36.9	103.5	47	G 2	2.3	2.4	0.00364

See product numbers and QR codes in section [Product numbers](#) on page 33.

TM05 1673 4111

TM05 2364 5011

## ALPHA2/3 32-60 (N)

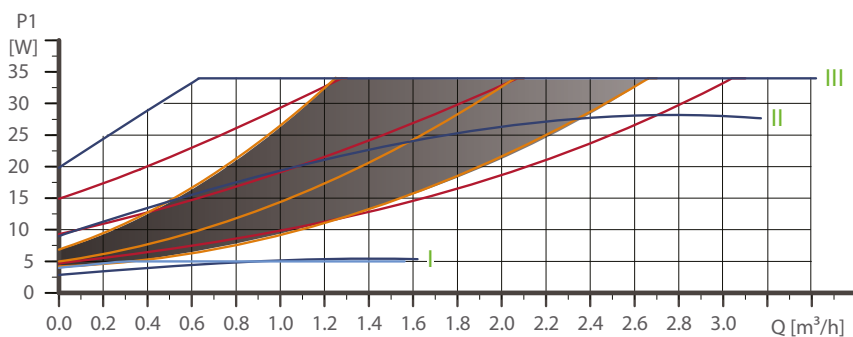
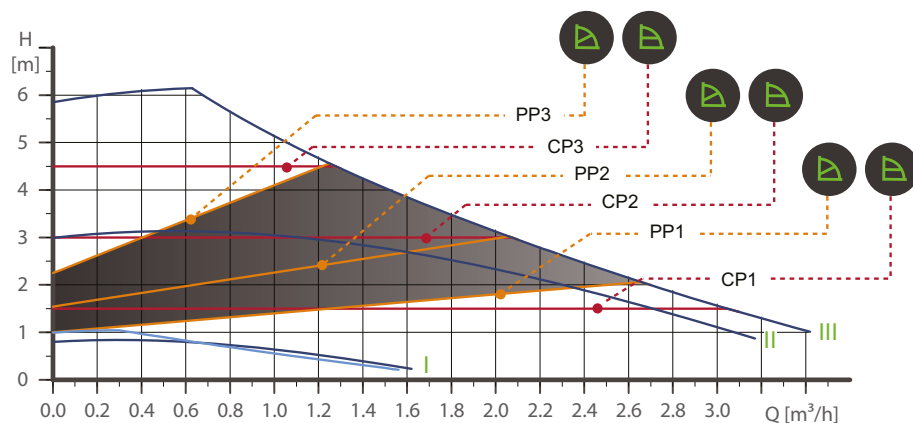

Speed	P1 [W]	I <sub>l</sub> [A]
<b>AUTO<sub>ADAPT</sub></b>	4-34	0.04 - 0.32
<b>Min.</b>	3	0.04
<b>Max.</b>	34	0.32

The pump incorporates overload protection.

Connections: See [Unions and valve kits](#), page 31.

System pressure: Maximum 1.0 MPa (10 bar).

Liquid temperature: 2-110 °C (TF 110).

Also available with: Stainless-steel pump housing, type N.

Specific EEI: ≤ 0.17.

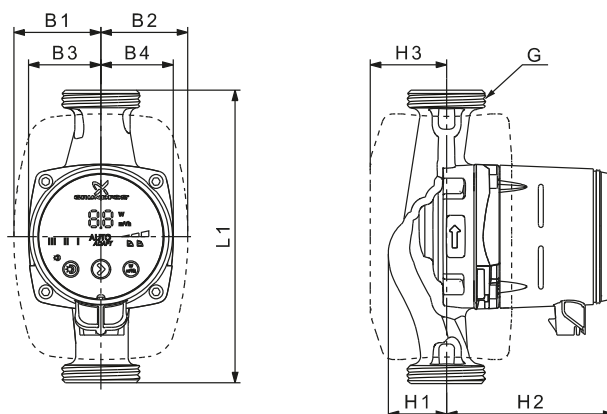

Pump type	Dimensions [mm]									Weights [kg]		Ship. vol. [m³]
	L1	B1	B2	B3	B4	H1	H2	H3	G	Net	Gross	
ALPHA2/3 32-60	180	54	54	44.5	44.5	35.9	103.5	47	G 2	2.1	2.3	0.00364
ALPHA2 32-60 N	180	54	54	44.5	44.5	36.9	103.5	47	G 2	2.3	2.4	0.00364

See product numbers and QR codes in section [Product numbers](#) on page 33.

TM05 1674 4111 - TM06 3966 1315

TM05 2364 5011

## ALPHA2/3 32-80 (N)

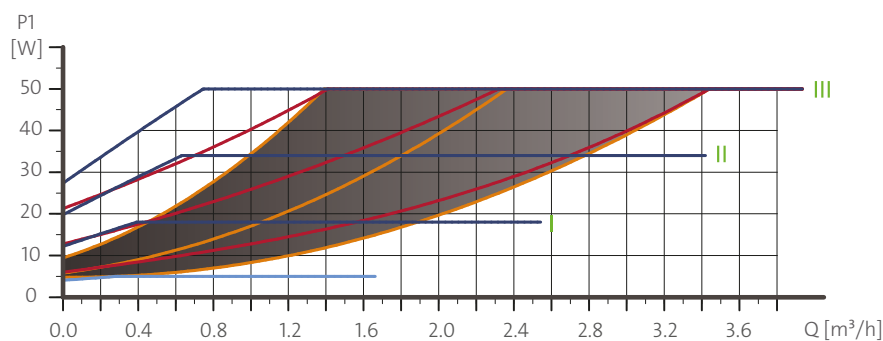
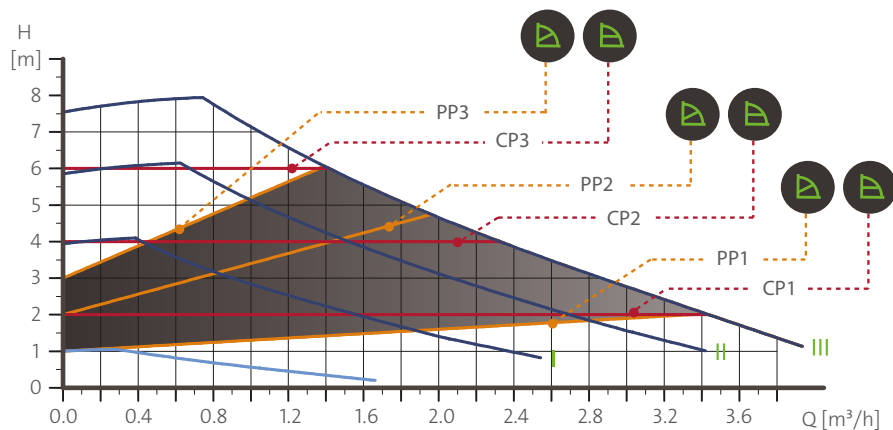

Speed	P1 [W]	I <sub>1</sub> [A]
<b>AUTO<sub>ADAPT</sub></b>	4-50	0.04 - 0.44
<b>Min.</b>	3	0.04
<b>Max.</b>	50	0.44

The pump incorporates overload protection.

Connections: See [Unions and valve kits](#), page 31.

System pressure: Maximum 1.0 MPa (10 bar).

Liquid temperature: 2-110 °C (TF 110).

Also available with: Stainless-steel pump housing, type N.

Specific EEI: ≤ 0.18.

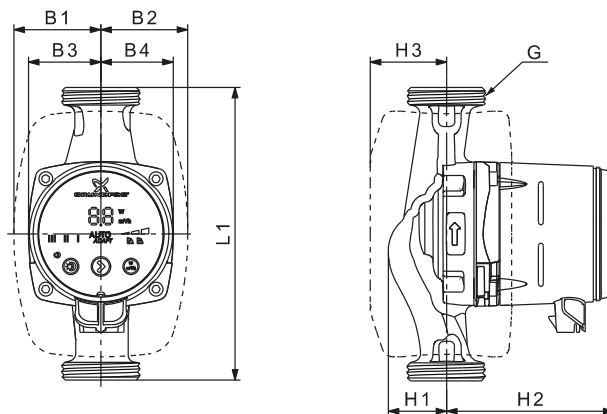

Pump type	Dimensions [mm]									Weights [kg]		Ship. vol. [m <sup>3</sup> ]
	L1	B1	B2	B3	B4	H1	H2	H3	G	Net	Gross	
ALPHA2/3 32-80	180	54	54	44.5	44.5	35.9	103.5	47	G 2	2.1	2.3	0.00364
ALPHA2 32-80 N	180	54	54	44.5	44.5	36.9	103.5	47	G 2	2.3	2.4	0.00364













See product numbers and QR codes in section [Product numbers](#) on page 33.

TM06 1285 2114

TM05 2364 5011

## 8. Accessories

### Unions and valve kits

		Product numbers, unions													
ALPHA2/3	Connection	Union nut with internal threads			Union nut with external threads		Ball valve with internal threads			Ball valve with Compression fitting		Union nut with soldering fitting			
															
15-xx*	G 1	3/4	1	1 1/4	1	1 1/4	3/4	1	1 1/4	Ø22	Ø28	Ø18	Ø22	Ø28	Ø42
15-xx N*															
25-xx	G 1 1/2	529921	<b>529922</b>	529821	529925	529924									
25-xx N			529971	<b>529972</b>				519805	519806	519807	519808	519809	529977	529978	529979
32-xx	G 2		509921	<b>509922</b>											
32-xx N				<b>509971</b>											

Note: The product numbers are always for one complete set, incl. gaskets.  
 The product numbers for the very standard sizes are printed in bold.  
 \*) When ordering for UK 15-xx versions, use product numbers for 25-xx (G 1 1/2).

G-threads have a cylindrical form in accordance with the EN ISO 228-1 standard and are not sealing the thread, it requires a flat gasket. You can only screw male G-threads (cylindrical) into female G-threads. The G-threads are standard thread on the pump housing.

R-threads are tapered external threads in accordance with the EN 10226-1 standard.

Rc- or Rp-threads are internal threads with either tapered or cylindrical (parallel) threads. You can screw male R-threads (conical) into female Rc- or Rp-threads. See fig. 25.

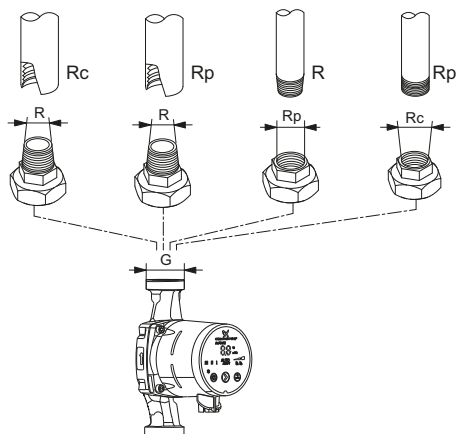

Fig. 25 Thread types and combinations (examples)

TM06 9235 2017

### Insulating kits

The pump is supplied with two insulating shells. Type A pumps with air-separating chamber are not supplied with insulating shells, but you can order them as an accessory. See the table below.

The insulating kit, which is tailored to the individual pump type, encloses the entire pump housing. It's easy to fit the two insulating shells around the pump. See fig. 26.

Pump type	Product number	Available
ALPHA2/3 XX-XX 130	98091786	spare part
ALPHA2/3 XX-XX 180	98091787	spare part
ALPHA2/3 XX-XX A	505822	accessory



Fig. 26 Insulating shells

TM06 5622 02 16

## ALPHA plugs



Fig. 27 ALPHA plugs

Pos.	Description	Product number	Available
1	ALPHA plug with cable gland, standard plug connector, complete	98284561	Spare part
2	ALPHA plug angled 90 ° left, with cable gland	98610291	Accessory
3	ALPHA plug angled 90 ° left, including 4 m cable	96884669	Accessory
4*	ALPHA plug angled 90 ° left, including 1 m cable and integrated NTC protection resistor	97844632	Accessory

\* This special cable with an active built-in NTC protection circuit, will reduce possible inrush currents. To be used in case of e.g poor quality of relay components that are sensitive to inrush current.

**Note:** ALPHA SOLAR cables and plugs, for the power and signal connection, are included in the delivery.

## ALPHA Reader



The ALPHA Reader unit MI401 is the receiver and transmitter of pump performance data. The unit broadcasts the measured data from the pump to an Android or iOS-based mobile device via Bluetooth. The unit uses a small lithium battery.

The unit is together with the Grundfos GO Balance app used for balancing heating system primarily in one- and two family houses. The app guides you through a number of steps where information on installation and measurements from the pump is being collected. In a two-pipe system or an underfloor heating system, the app calculates the balancing values for each of the valves. On the basis of these values, the app guides you through the adjustment of each presetting valve in the system.

The app is available for both Android and iOS devices, and you can download it free of charge from Google Play and App Store.

Description	Product number
ALPHA reader MI401	98916967

























## 9. Product numbers

### ALPHA2 for the D-A-CH market\* (Germany, Austria and Switzerland)

\* model E

**Note:** Click on the product number and go directly to the performance curve in Grundfos Product Center (GPC).















Pump type	Port-to-port length [mm]	Connection	Product number	Data sheet Page	Weights gross [kg]	Ship. vol. [m <sup>3</sup> ]	QR code for GPC
ALPHA2 15-40	130	G 1	99261679	<a href="#">17</a>	1.9	0.00364	
ALPHA2 15-60	130	G 1	99261696	<a href="#">19</a>	1.9	0.00364	
ALPHA2 15-80	130	G 1	99261699	<a href="#">20</a>	1.9	0.00364	
ALPHA2 25-40	130	G 1 1/2	99261701	<a href="#">22</a>	2.0	0.00364	
ALPHA2 25-40 N	130	G 1 1/2	99271964	<a href="#">21</a>	2.1	0.00364	
ALPHA2 25-60	130	G 1 1/2	99261724	<a href="#">25</a>	2.0	0.00364	
ALPHA2 25-60 N	130	G 1 1/2	99271967	<a href="#">24</a>	2.1	0.00364	
ALPHA2 25-80	130	G 1 1/2	99261726	<a href="#">26</a>	2.0	0.00364	
ALPHA2 25-80 N	130	G 1 1/2	99271968	<a href="#">26</a>	2.1	0.00364	
ALPHA2 25-40	180	G 1 1/2	99260497	<a href="#">22</a>	2.1	0.00364	
ALPHA2 25-40 A	180	G 1 1/2	99261727	<a href="#">22</a>	3.0	0.00420	
ALPHA2 25-40 N	180	G 1 1/2	99271969	<a href="#">22</a>	2.3	0.00364	
ALPHA2 25-60	180	G 1 1/2	99261730	<a href="#">25</a>	2.1	0.00364	

Pump type	Port-to-port length [mm]	Connection	Product number	Data sheet Page	Weights gross [kg]	Ship. vol. [m <sup>3</sup> ]	QR code for GPC
ALPHA2 25-60 A	180	G 1 1/2	99261734	<a href="#">25</a>	3.0	0.00420	
ALPHA2 25-60 N	180	G 1 1/2	99271971	<a href="#">24</a>	2.3	0.00364	
ALPHA2 25-80	180	G 1 1/2	99261732	<a href="#">26</a>	2.1	0.00364	
ALPHA2 25-80 N	180	G 1 1/2	99271972	<a href="#">26</a>	2.3	0.00364	
ALPHA2 32-40	180	G 2	99261735	<a href="#">27</a>	2.3	0.00364	
ALPHA2 32-40 N	180	G 2	99271994	<a href="#">27</a>	2.4	0.00364	
ALPHA2 32-60	180	G 2	99261737	<a href="#">29</a>	2.3	0.00364	
ALPHA2 32-60 N	180	G 2	99271995	<a href="#">29</a>	2.4	0.00364	
ALPHA2 32-80	180	G 2	99261738	<a href="#">30</a>	2.3	0.00364	
ALPHA2 32-80 N	180	G 2	99271996	<a href="#">30</a>	2.4	0.00364	

**ALPHA3 for the D-A-CH market\* (Germany, Austria and Switzerland)**















\* Including ALPHA Reader and ALPHA angle plug, enclosed in the box.















**Note:** Click on the product number and go directly to the performance curve in Grundfos Product Center (GPC).

Pump type	Port-to-port length [mm]	Connection	Product number	Data sheet Page	Weights gross [kg]	Ship. vol. [m <sup>3</sup> ]	QR code for GPC
ALPHA3 15-40	130	G 1	99272001	<a href="#">17</a>	1.9	0.00384	
ALPHA3 15-60	130	G 1	99272005	<a href="#">19</a>	1.9	0.00384	
ALPHA3 15-80	130	G 1	99272006	<a href="#">20</a>	1.9	0.00384	
ALPHA3 25-40	130	G 1 1/2	99272009	<a href="#">21</a>	2.0	0.00384	
ALPHA3 25-60	130	G 1 1/2	99272011	<a href="#">24</a>	2.0	0.00384	
ALPHA3 25-80	130	G 1 1/2	99272023	<a href="#">26</a>	2.0	0.00384	
ALPHA3 25-40	180	G 1 1/2	99272024	<a href="#">21</a>	2.2	0.00384	
ALPHA3 25-40A	180	G 1 1/2	99272025	<a href="#">22</a>	3.0	0.00420	
ALPHA3 25-60	180	G 1 1/2	99272026	<a href="#">24</a>	2.2	0.00384	
ALPHA3 25-60A	180	G 1 1/2	99272028	<a href="#">25</a>	3.0	0.00420	
ALPHA3 25-80	180	G 1 1/2	99272027	<a href="#">26</a>	2.2	0.00384	
ALPHA3 32-40	180	G 2	99272029	<a href="#">27</a>	2.3	0.00384	
ALPHA3 32-60	180	G 2	99272030	<a href="#">29</a>	2.3	0.00384	
ALPHA3 32-80	180	G 2	99272031	<a href="#">30</a>	2.3	0.00384	

## ALPHA2 for the international market

**Note:** Click on the product number and go directly to the performance curve in Grundfos Product Center (GPC).













Pump type	Port-to-port length [mm]	Connection	Product number	Data sheet Page	Weights gross [kg]	Ship. vol. [m <sup>3</sup> ]	QR code for GPC
ALPHA2 15-40	130	G 1	97993192	<a href="#">17</a>	1.9	0.00364	
ALPHA2 15-50	130	G 1	97993193	<a href="#">18</a>	1.9	0.00364	
ALPHA2 15-60	130	G 1	97993194	<a href="#">19</a>	1.9	0.00364	
ALPHA2 15-80	130	G 1	98676765	<a href="#">20</a>	1.9	0.00364	
ALPHA2 25-40	130	G 1 1/2	97993195	<a href="#">21</a>	2.0	0.00364	
ALPHA2 25-40 N	130	G 1 1/2	97993206	<a href="#">21</a>	2.1	0.00364	
ALPHA2 25-50	130	G 1 1/2	97993196	<a href="#">23</a>	2.0	0.00364	
ALPHA2 25-50 N	130	G 1 1/2	97993207	<a href="#">23</a>	2.1	0.00364	
ALPHA2 25-60	130	G 1 1/2	97993197	<a href="#">24</a>	2.0	0.00364	
ALPHA2 25-60 N	130	G 1 1/2	97993208	<a href="#">24</a>	2.1	0.00364	
ALPHA2 25-80	130	G 1 1/2	98649753	<a href="#">26</a>	2.0	0.00364	
ALPHA2 25-80 N	130	G 1 1/2	98676782	<a href="#">26</a>	2.1	0.00364	
ALPHA2 25-40	180	G 1 1/2	97704990	<a href="#">21</a>	2.1	0.00364	
ALPHA2 25-40 N	180	G 1 1/2	97993209	<a href="#">21</a>	2.3	0.00364	







Pump type	Port-to-port length [mm]	Connection	Product number	Data sheet Page	Weights gross [kg]	Ship. vol. [m <sup>3</sup> ]	QR code for GPC
ALPHA2 25-40 A	180	G 1 1/2	97993199	<a href="#">20</a>	3.0	0.00420	
ALPHA2 25-50	180	G 1 1/2	97993200	<a href="#">23</a>	2.1	0.00364	
ALPHA2 25-50 N	180	G 1 1/2	97993210	<a href="#">23</a>	2.3	0.00364	
ALPHA2 25-60	180	G 1 1/2	97993201	<a href="#">24</a>	2.1	0.00364	
ALPHA2 25-60 N	180	G 1 1/2	97993211	<a href="#">24</a>	2.3	0.00364	
ALPHA2 25-60 A	180	G 1 1/2	97993202	<a href="#">25</a>	3.0	0.00420	
ALPHA2 25-80	180	G 1 1/2	98649757	<a href="#">26</a>	2.1	0.00364	
ALPHA2 25-80 N	180	G 1 1/2	98676783	<a href="#">26</a>	2.3	0.00364	
ALPHA2 32-40	180	G 2	97993203	<a href="#">27</a>	2.3	0.00364	
ALPHA2 32-40 N	180	G 2	97993212	<a href="#">27</a>	2.4	0.00364	
ALPHA2 32-50	180	G 2	97993204	<a href="#">28</a>	2.3	0.00364	
ALPHA2 32-50 N	180	G 2	97993213	<a href="#">28</a>	2.4	0.00364	
ALPHA2 32-60	180	G 2	97993205	<a href="#">29</a>	2.3	0.00364	
ALPHA2 32-60 N	180	G 2	97993214	<a href="#">29</a>	2.4	0.00364	
ALPHA2 32-80	180	G 2	98676766	<a href="#">30</a>	2.3	0.00364	

Pump type	Port-to-port length [mm]	Connection	Product number	Data sheet Page	Weights gross [kg]	Ship. vol. [m <sup>3</sup> ]	QR code for GPC
ALPHA2 32-80 N	180	G 2	98676784	<a href="#">30</a>	2.4	0.00364	

## ALPHA3 for the international market



**Note:** Click on the product number and go directly to the performance curve in Grundfos Product Center (GPC).

Pump type	Port-to-port length [mm]	Connection	Product number	Data sheet Page	Weights gross [kg]	Ship. vol. [m <sup>3</sup> ]	QR code for GPC
ALPHA3 15-40	130	G 1	98890717	<a href="#">17</a>	1.9	0.00364	
ALPHA3 15-50	130	G 1	98890746	<a href="#">18</a>	1.9	0.00364	
ALPHA3 15-60	130	G 1	98890747	<a href="#">19</a>	1.9	0.00364	
ALPHA3 15-80	130	G 1	98890748	<a href="#">20</a>	1.9	0.00364	
ALPHA3 25-40	130	G 1 1/2	98890750	<a href="#">21</a>	2.0	0.00364	
ALPHA3 25-50	130	G 1 1/2	98890761	<a href="#">23</a>	2.0	0.00364	
ALPHA3 25-60	130	G 1 1/2	98890762	<a href="#">24</a>	2.0	0.00364	
ALPHA3 25-80	130	G 1 1/2	98890764	<a href="#">26</a>	2.0	0.00364	
ALPHA3 25-40	180	G 1 1/2	98890766	<a href="#">21</a>	2.1	0.00364	
ALPHA3 25-40 A	180	G 1 1/2	98890767	<a href="#">22</a>	3.0	0.00420	
ALPHA3 25-50	180	G 1 1/2	98890768	<a href="#">23</a>	2.1	0.00364	
ALPHA3 25-60	180	G 1 1/2	98890769	<a href="#">24</a>	2.1	0.00364	

Pump type	Port-to-port length [mm]	Connection	Product number	Data sheet Page	Weights gross [kg]	Ship. vol. [m <sup>3</sup> ]	QR code for GPC
ALPHA3 25-60 A	180	G 1 1/2	98890781	<a href="#">25</a>	3.0	0.00420	
ALPHA3 25-80	180	G 1 1/2	98890770	<a href="#">26</a>	2.1	0.00364	
ALPHA3 32-40	180	G 2	98890783	<a href="#">27</a>	2.3	0.00364	
ALPHA3 32-50	180	G 2	98890784	<a href="#">28</a>	2.3	0.00364	
ALPHA3 32-60	180	G 2	98890785	<a href="#">29</a>	2.3	0.00364	
ALPHA3 32-80	180	G 2	98890786	<a href="#">30</a>	2.3	0.00364	



## ALPHA2 for the UK market

**Note:** Click on the product number and go directly to the performance curve in Grundfos Product Center (GPC).

Pump type	Port-to-port length [mm]	Connection	Product number	Data sheet Page	Weights gross [kg]	Ship. vol. [m <sup>3</sup> ]	QR code for GPC
ALPHA2 15-50/60	130	G 1 1/2	98734596	<a href="#">18</a>	2.0	0.00364	
ALPHA2 15-50/60 N	130	G 1 1/2	98762637	<a href="#">18</a>	2.1	0.00364	
ALPHA2 25-80	130	G 1 1/2	98649774	<a href="#">26</a>	2.0	0.00364	







## ALPHA3 for the UK market

**Note:** Click on the product number and go directly to the performance curve in Grundfos Product Center (GPC).

Pump type	Port-to-port length [mm]	Connection	Product number	Data sheet Page	Weights gross [kg]	Ship. vol. [m <sup>3</sup> ]	QR code for GPC
ALPHA3 15-50/60	130	G 1 1/2	98890833	<a href="#">18</a>	2.0	0.00364	
ALPHA3 25-80	130	G 1 1/2	98890831	<a href="#">26</a>	2.0	0.00364	

## ALPHA2 for the Russian market







**Note:** Click on the product number and go directly to the performance curve in Grundfos Product Center (GPC).

Pump type	Port-to-port length [mm]	Connection	Product number	Data sheet Page	Weights gross [kg]	Ship. vol. [m <sup>3</sup> ]	QR code for GPC
ALPHA2 25-40 *	180	G 1 1/2	98520745	<a href="#">21</a>	2.5	0.00420	
ALPHA2 25-60 *	180	G 1 1/2	98520749	<a href="#">24</a>	2.5	0.00420	
ALPHA2 25-80 *	180	G 1 1/2	98649772	<a href="#">26</a>	2.5	0.00420	
ALPHA2 32-40	180	G 2	98520750	<a href="#">27</a>	2.3	0.00420	
ALPHA2 32-60	180	G 2	98520754	<a href="#">29</a>	2.3	0.00420	
ALPHA2 32-80	180	G 2	98914896	<a href="#">30</a>	2.3	0.00420	

\* Including union kit Rp 1"

## ALPHA3 for the Russian market

**Note:** Click on the product number and go directly to the performance curve in Grundfos Product Center (GPC).

Pump type	Port-to-port length [mm]	Connection	Product number	Data sheet Page	Weights gross [kg]	Ship. vol. [m <sup>3</sup> ]	QR code for GPC
ALPHA3 25-40 *	180	G 1 1/2	98890810	<a href="#">21</a>	2.5	0.00420	
ALPHA3 25-60 *	180	G 1 1/2	98890811	<a href="#">24</a>	2.5	0.00420	
ALPHA3 25-80 *	180	G 1 1/2	98890812	<a href="#">26</a>	2.5	0.00420	
ALPHA3 32-40	180	G 2	98890813	<a href="#">27</a>	2.3	0.00420	
ALPHA3 32-60	180	G 2	98890814	<a href="#">29</a>	2.3	0.00420	
ALPHA3 32-80	180	G 2	98890818	<a href="#">30</a>	2.3	0.00420	

\* Including union kit Rp 1"



## 10. ALPHA SOLAR



TM06 5816 0216

### Product description

The ALPHA SOLAR is designed to be integrated in all kinds of thermal solar systems with either variable or constant flow rate. High-efficiency ECM (Electronically Commutated Motor) pumps, such as ALPHA SOLAR, must not be speed-controlled by an external speed controller varying or pulsing the supply voltage.

The speed can be controlled by a low-voltage PWM (Pulse Width Modulation) signal from a solar controller to optimise the solar harvesting and temperature of the system. As a result, the power consumption of the pump will be reduced considerably.

If no PWM signal is available, you can set ALPHA SOLAR to operate at constant speed / constant curve, only switched on and off by the controller.

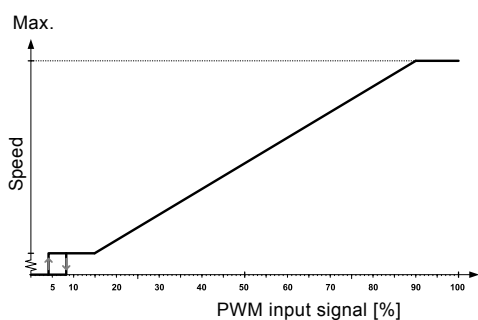

TM05 1575 3211

Fig. 28 PWM input profile C (solar)

### Features

- Four different constant speed settings
- PWM C profile. The PWM signal is a method for generating an analog signal using a digital source.

### Benefits

- Low EEI (Energy Efficiency Index),  $EEI \leq 0.20$
- Maintenance-free
- Low noise level
- Very simple installation
- Compact
- Deblocking screw
- High ambient temperature (70 °C).

### Technical data

<b>System pressure</b>	Maximum 1.0 MPa (10 bar)
<b>Minimum inlet pressure</b>	0.05 MPa (0.50 bar) at 95 °C liquid temperature
<b>Maximum liquid temperature</b>	2-110 °C at 70 °C ambient temperature 2-130 °C at 60 °C ambient temperature
<b>Enclosure class</b>	IPX4D
<b>Motor protection</b>	No external protection needed
<b>Approval and marking</b>	VDE, CE
<b>Water/propylene glycol mixture</b>	Maximum water/propylene glycol mixture is 50 %. Note: The water/propylene glycol mixture reduces the performance due to higher viscosity.

### Replacement table

Old existing products	Replaced by
96817710 SOLAR 15-45 130	98989298 ALPHA SOLAR 15-75 130
96705819 SOLAR 15-60 130	98989298 ALPHA SOLAR 15-75 130
96817649 SOLAR 15-65 130	98989298 ALPHA SOLAR 15-75 130
59508500 SOLAR 15-80 130	98989298 ALPHA SOLAR 15-75 130
59544183 SOLAR 25-40 180	98989300 ALPHA SOLAR 25-75 180
96817722 SOLAR 25-45 130	98989299 ALPHA SOLAR 25-75 130
96817725 SOLAR 25-45 180	98989300 ALPHA SOLAR 25-75 180
59546639 SOLAR 25-60 180	98989300 ALPHA SOLAR 25-75 180
96817652 SOLAR 25-65 130	98989299 ALPHA SOLAR 25-75 130
96817707 SOLAR 25-65 180	98989300 ALPHA SOLAR 25-75 180
52588352 SOLAR 25-120 180	98989297 ALPHA SOLAR 25-145 180

## Operating mode

This circulator pump is either for external PWM signal control with profile C or internal control with constant-curve mode. See fig. 29.

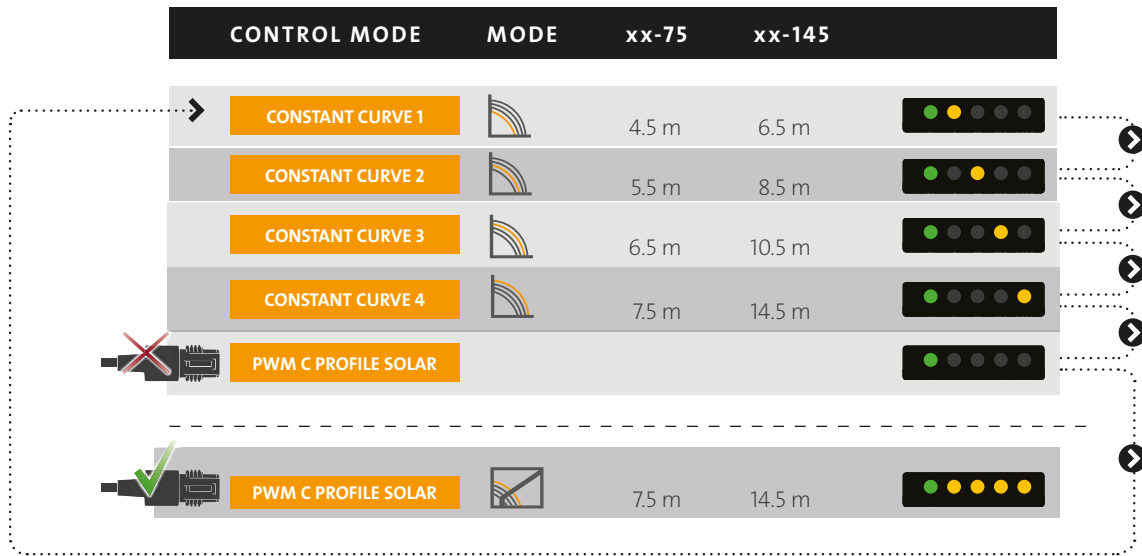

Fig. 29 Operating mode

TM06 5817 0216

## Alarm status

### Alarm status

If the circulator has detected one or more alarms, the first LED switches from green to red. When an alarm is active, the LEDs indicate the alarm type as defined in the table below. If multiple alarms are active at the same time, the LEDs only show the error with the highest priority. The priority is defined by the sequence of the table.

When there is no active alarm anymore, the control panel switches back to operating status.

Control panel	Description
[Red, Green, Yellow, Blue LEDs]	Blocked
[Red, Green, Yellow, Blue LEDs]	Supply voltage low
[Red, Green, Yellow, Blue LEDs]	Electrical error

## Control box connections

The ALPHA SOLAR control box has two electrical connections on one side: the power supply and signal connection.

### Signal connection

The PWM signal connection is covered by a blind plug from factory. See fig. 30.



Fig. 30 Control box connections

TM06 5819 0216

## Power supply connection

The circulator pump must be connected to the power supply with the enclosed Superseal connector plug. Adapters are available for cables with Molex or Volex connectors.

### Superseal power connector



TM06 5820 0216

Fig. 31 Superseal power connector

### Reliability

- Temperature-proof and fireproof wire
- waterproof.

### Safety

Additional locking latch (pull-out force larger than 100 N).

## Control signal connection

The control signal cable connection has three leads: signal input, signal output and signal reference. Connect the cable to the control box by a Mini Superseal plug. An optional signal cable (1 meter) is delivered with the circulator as an accessory. The cable length can be maximum 3 metres.

### Mini Superseal



TM06 58210216

Fig. 32 Mini Superseal

### Safety

Additional locking latch with a pull-out force larger than 100 N.

### PWM external control mode and signals

If you want to use PWM control of the pump, contact Grundfos for further information.

## Digital signal converter

To replace UPS SOLAR with a new ALPHA SOLAR which fulfils the ErP requirements, we offer two solutions:

- Exchange the existing SOLAR controller to a controller suitable for high-efficiency pumps.
- Keep the old controller, and use the phase control. Use a signal converter, SIKON HE, which can convert the existing phase control to a PWM signal for the ALPHA SOLAR.

When you use SIKON HE, you can replace the conventional 230 V UPS SOLAR pumps with Grundfos ALPHA SOLAR pumps without having to change the controller. The function of the performance control of the pump is maintained.



TM065809 0216

Fig. 33 Digital signal converter (SIKON HE)

For further information about the controller, see [www.prozeda.de](http://www.prozeda.de).

### ALPHA SOLAR xx-75 130/180 (N)

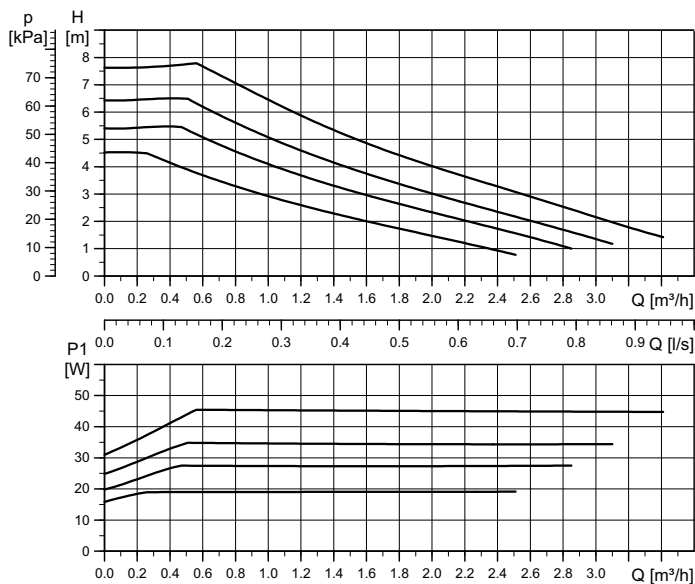

Setting	Max. head <sub>nom</sub>
Curve 1	4.5 m
Curve 2	5.5 m
Curve 3	6.5 m
Curve 4	7.5 m

Setting	Max. P <sub>1</sub> nom
Curve 1	19 W
Curve 2	28 W
Curve 3	35 W
Curve 4	45 W

EEl ≤ 0.20 Part 3  
 P<sub>L,avg</sub> ≤ 20 W

TM06 3658 0815

**Note:** PWM speed curves on request.

Electrical data, 1 x 230 V, 50 Hz		
Speed	P <sub>1</sub> [W]	I <sub>1/1</sub> [A]
Min.	2*	0.04
Max.	45	0.48

Settings			
PWM C	PP	CP	CC
1	-	-	4

\* Only in PWM minimum speed operation.

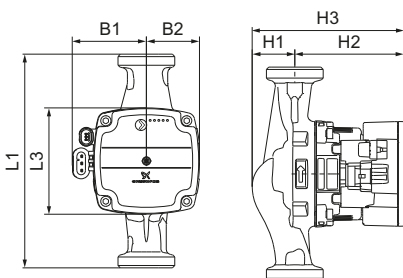

TM06 6493 1516



TM06 5636 5115

Pump type	Dimensions [mm]							Connections	Weight [kg]
	L1	L3	B1	B2	H1	H2	H3		
ALPHA SOLAR 15-75 130	130	90	72	45	36	92	128	G 1	1.8
ALPHA SOLAR 25-75 130	130	90	72	45	36	92	128	G 1 1/2	1.9
ALPHA SOLAR 25-75 180	180	90	72	45	36	92	128	G 1 1/2	2.0

**ALPHA SOLAR xx-145 180**

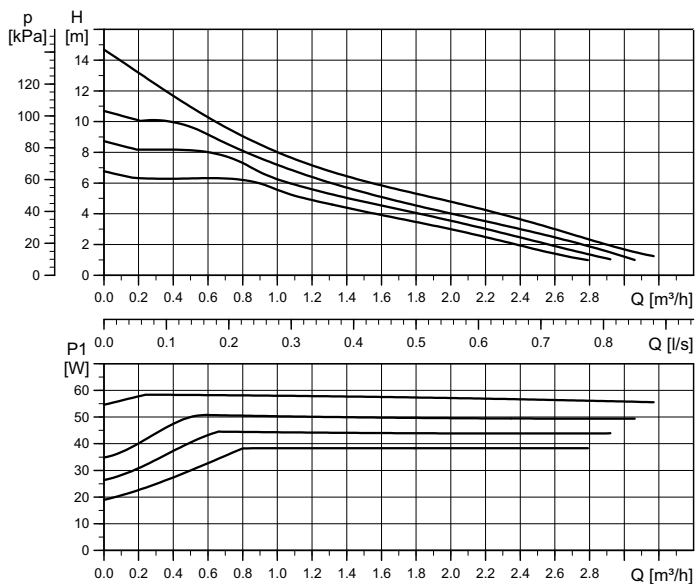

Setting	Max. head <sub>nom</sub>
Curve 1	6.5 m
Curve 2	8.5 m
Curve 3	10.5 m
Curve 4	14.5 m

Setting	Max. P <sub>1</sub> nom
Curve 1	39 W
Curve 2	45 W
Curve 3	52 W
Curve 4	60 W

EEl ≤ 0.20 Part 3  
P<sub>L,avg</sub> ≤ 25 W

TM06 3652 0815

**Note:** PWM speed curves on request.

Electrical data, 1 x 230 V, 50 Hz		
Speed	P <sub>1</sub> [W]	I <sub>1/1</sub> [A]
Min.	2*	0.04
Max.	60	0.58

Settings			
PWM C	PP	CP	CC
1	-	-	4

\* Only in PWM minimum speed operation.

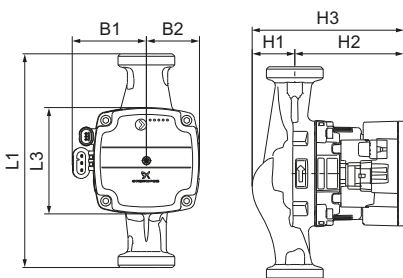

TM06 6493 1516







TM06 5636 5115

Pump type	Dimensions [mm]							Connections	Weight [kg]
	L1	L3	B1	B2	H1	H2	H3		
ALPHA SOLAR 25-145 180	180	90	72	45	25	103	128	G 1 1/2	2.0

## ALPHA SOLAR for the international market

**Note:** Click on the product number and go directly to the performance curve in Grundfos Product Center (GPC).

Pump type	Port-to-port length [mm]	Connection	Product number	Data sheet Page	QR code for GPC
ALPHA SOLAR 15-75	130	G 1	98989298	<a href="#">17</a>	
ALPHA2 SOLAR 25-75	130	G 1 1/2	98989299	<a href="#">18</a>	
ALPHA2 SOLAR 25-75	180	G 1 1/2	98989300	<a href="#">19</a>	
ALPHA2 SOLAR 25-145	180	G 1 1/2	98989297	<a href="#">19</a>	

## 11. Grundfos Product Center

Online search and sizing tool to help you make the right choice.

<http://product-selection.grundfos.com>



"SIZING" enables you to size a pump based on entered data and selection choices.

"REPLACEMENT" enables you to find a replacement product. Search results will include information on the following:

- the lowest purchase price
- the lowest energy consumption
- the lowest total life cycle cost.

The screenshot shows the Grundfos Product Center website. The header includes the logo, navigation menu (HOME, FIND PRODUCT, COMPARE, YOUR PROJECTS, SAVED ITEMS, HELP), and user options (Login, Product range: United Kingdom | 50 Hz | Language: English, Change settings). The main content area is titled 'FIND PRODUCTS AND SOLUTIONS' and features a search bar and four main navigation buttons: SIZING (Enter pump sizing), CATALOGUE (Products and services), REPLACEMENT (Replace an old pump with a new), and LIQUIDS (Find pump by liquid). Below these is a 'QUICK SIZING' section with input fields for 'Enter duty point' (Flow (Q)\* in m³/h and Head (H)\* in m) and 'Select what to size by' (radio buttons for Size by application, Size by pump design, and Size by pump family). A 'START SIZING' button is also present. At the bottom, there are links for 'ADVANCED SIZING' (Advanced sizing by application and Guided selection).

"CATALOGUE" gives you access to the Grundfos product catalogue.

"LIQUIDS" enables you to find pumps designed for aggressive, flammable or other special liquids.

### All the information you need in one place

Performance curves, technical specifications, pictures, dimensional drawings, motor curves, wiring diagrams, spare parts, service kits, 3D drawings, documents, system parts. The Product Center displays any recent and saved items - including complete projects - right on the main page.

### Downloads

On the product pages, you can download installation and operating instructions, data booklets, service instructions, etc. in PDF format.

Subject to alterations.

be think innovate

---

<b>98144996</b> 0817
----------------------

ECM: 1211260
--------------

**GRUNDFOS A/S**  
DK-8850 Bjerringbro . Denmark  
Telephone: +45 87 50 14 00  
[www.grundfos.com](http://www.grundfos.com)

**GRUNDFOS** 

© Copyright Grundfos Holding A/S

The name Grundfos, the Grundfos logo, and be think innovate are registered trademarks owned by Grundfos Holding A/S or Grundfos A/S, Denmark. All rights reserved worldwide.